



PREMIUM-WERKZEUGE



PREMIUM TOOLS



www.kstools.com

CUTTING TOOLS

MACHINING TOOLS / BRUSHES AND FILES

Drills



Drilling: Technical information: Guidelines for drilling speeds feed rate and cooling

The table provides approximate values. According to drilling depth and thickness of the material, an increase or reduction in the cutting speed feed rate or cutting fluid would be recommended. The values for -v- and -s- indicated value apply to drilling depths until 5 x d (d = drilling diameter) In drilling depths over 5 x d until 8 x d then -v- and -s- should be reduced around 20% to 30%. In general in drilling depths over 5 x d the hole should be cleaned!

Material grade	Cooling	Drilling speed v0m/min	s= feed rate n= speed	Twist drill diameter D [mm]							
				1*	2	5	8	16	25	40	63
				Feed rate s				[mm/U] and medium speed n [U/mi]			
Non alloyed steel up to 500 N/m ²	Oil and water emulsion	30-40	s n	Hand 11100	0,05 5600	0,12 2200	0,2 1400	0,3 700	0,4 450	0,4 280	0,5 180
Non alloyed steel 500-700 N/m ²		25-30	s n	Hand 8800	0,05 4400	0,12 1750	0,2 1100	0,3 550	0,4 350	0,4 220	0,5 140
Non alloyed steel above 700 N/m ²		20-25	s n	Hand 7200	0,04 3600	0,1 1400	0,15 900	0,25 445	0,3 285	0,3 180	0,4 114
Alloyed steel 700-900 N/m ²		12-15	s n	Hand 4300	0,03 2150	0,08 860	0,12 540	0,2 270	0,25 170	0,32 110	0,36 68
Alloyed steel 900-1100 N/m ²	Cutting oil	8-15	s n	Hand 3650	Hand 1840	0,06 735	0,001 455	0,2 230	0,3 145	0,3 90	0,3 60
Alloyed steel above 1100 N/m ²		5-8	s n	Hand 2100	Hand 1050	0,04 415	0,06 260	0,1 130	0,12 83	0,16 52	0,18 33
Rust steady, acid steady steels (highly Cr, Ni-alloy)		5-10	s n	Hand 2400	Hand 1200	0,05 480	0,1 300	0,15 150	0,2 95	0,2 60	0,3 38
High tensile steel (high Co, Cr, Mo, Ni, W alloys)	Cutting oil	4-8	s n	Hand 1900	Hand 950	0,02 380	0,06 240	0,09 120	0,15 76	0,2 48	0,24 30
Sprung steel band (high Si alloy)		3-6	s n	Hand 1430	Hand 720	0,04 285	0,06 180	0,1 90	0,12 57	0,16 36	0,18 23
Manganese steel (Mn-10%, C- 05%)	without cooling the material must be heated to 300	2-5	s n	Hand 1300	Hand 650	0,05 255	0,08 160	0,1 80	0,15 50	0,2 32	0,2 20
Cast steel up to GS-52	Oil and water emulsion	20-25	s n	Hand 7200	0,03 3600	0,9 1400	0,14 900	0,24 445	0,3 285	0,38 180	0,43 114
Cast steel above GS-52		12-20	s n	Hand 5100	0,03 2550	0,08 1020	0,12 640	0,02 320	0,25 200	0,32 130	0,36 80
Cast iron up to GG-26	Compressed air	18-25	s n	Hand 6800	0,06 3400	0,16 1350	0,24 860	0,4 430	0,5 275	0,6 170	0,7 110
Cast iron above GG 26		5-15	s n	Hand 3200	0,05 1600	0,14 635	0,2 400	0,35 200	0,45 130	0,5 80	0,6 50
Cast iron (GTW/GTS)	Compressed air (Oil and water emulsion)	18-25	s n	Hand 6800	0,07 3400	0,12 1400	0,2 850	0,4 430	0,5 275	0,6 170	0,6 110
Refined copper	Oil and water emulsion (compressed air)	50-80	s n	Hand 2100	0,005 10500	0,15 4100	0,25 2600	0,4 1300	0,5 830	0,5 520	0,5 330
Brass, tough (MS 63)	Oil and water emulsion (Cutting oil)	40-30	s n	Hand 16000	0,05 8000	0,15 3200	0,25 2000	0,4 1000	0,5 640	0,6 400	0,7 250
Brass, alloy (MS 58) Bronze, soft (gun metal, Rg)	Cutting oil	20-30	s n	Hand 8000	0,04 4000	0,1 1600	0,15 1000	0,25 500	0,32 320	0,42 200	0,46 125
Bronze, hard (Bz; Äternabronze)		10-20	s n	Hand 4800	0,04 2400	0,1 960	0,15 600	0,25 300	0,32 190	0,42 120	0,46 75
Copper nickel alloy (e.g. nickel bronze approx. 67% Ni)	Cutting oil	5-15	s n	Hand 3200	0,02 1600	0,06 635	0,09 400	0,15 200	0,2 130	0,24 80	0,27 50
Aluminium	Oil and water emulsion	50-120	n	Hand 3200	0,02 1600	0,06 635	0,09 400	0,15 200	0,2 130	0,24 80	0,27 50
Nickel alloy aluminium (e.g. piston alloy)		20-44	s n	Hand 9600	0,04 4800	0,1 1900	0,15 1200	0,25 600	0,32 380	0,4 240	0,45 150

* When the diameter is below 1 mm the cutting speed should be reduced.

Stepped drills

Cutting recommendations for stepped drills

Material:		Non alloyed steel up to 700 N/mm ²	Alloyed steel up to 700 N/mm ²	Alloy steel 1000 N/mm ²	Cast iron up to 250 N/mm ²	Cast iron above 250 N/mm ²	CuZn refractory alloy	CuZn-refractory tough	Al refractory up to 11% Si
Metal gauge in mm		up to 4,0	up to 4,0	up to 4,0	up to 4,0	up to 4,0	up to 4,0	up to 4,0	up to 4,0
Vc = m/min		30	20	20	15	10	60	35	30
Cooling lubricant		Cutting edge spray	Cutting edge spray	Cutting edge spray	Pneumatic	Pneumatic	Pneumatic	Pneumatic	Cutting edge spray
Ø mm	Dim.	U/min	U/min	U/min	U/min	U/min	U/min	U/min	U/min
3,0-14,0	Nr. 1	3185-682	2123-455	2123-455	1592-341	1062-227	6369-1365	3715-796	3185-682
5,0-20,0	Nr. 2	1911-478	1274-318	1274-318	955-239	637-159	3822-955	2229-557	1911-478
16,0-30,5	Nr. 3	597-313	398-209	398-209	299-157	199-104	1194-627	697-365	597-313
24,0-40,0	Nr. 4	398-239	265-159	265-159	199-119	133-80	796-478	464-279	398-239
36,0-50,0	Nr. 5	265-191	177-127	177-127	133-96	88-64	531-382	310-223	265-191
40,0-61,0	Nr. 6	239-157	159-104	159-104	119-78	80-52	478-313	279-183	239-157
5,0-25,4	Nr. 7	1911-376	1274-251	1274-251	955-188	637-125	3822-752	2229-439	1911-376
5,0-31,0	Nr. 8	1911-308	1274-205	1274-205	955-154	637-103	3822-616	2229-360	1911-308
5,0-22,5	Nr. 9	1911-425	1274-283	1274-283	955-212	637-142	3822-849	2229-495	1911-425



Carbide milling cutters

Milling cutters up to and including head Ø 6 mm manufactured out of solid carbide steel beyond that the carbide is soldered on the head cutting edges. The special dovetailed cutting edge design C (after DIN tothing MX) has following advantages:

- Smooth running
- High material removal
- No clogging
- Comfortable working
- Short swarf
- Obtains even and smooth surfaces

Applications: Universal applications, for iron metals and non ferrous metals, for plastics, for plaster working areas, and hard material working, cast iron and titanium.
Recommended cutting speed for hard metal milling machine burrs Vc 450 - 600 ms/min



Manual and machine wire brushes



Files



Handsaws



Saw blades



	D mm	L1 mm	L2 mm	Content		€
330.1111	11,1	142,0	94,0	5	385	11,90
330.1112	11,2	142,0	94,0	5	385	11,90
330.1113	11,3	142,0	94,0	5	385	11,90
330.1114	11,4	142,0	94,0	5	385	11,90
330.1115	11,5	142,0	94,0	5	385	12,90
330.1116	11,6	142,0	94,0	5	440	12,90
330.1117	11,7	142,0	94,0	5	440	12,90
330.1118	11,8	142,0	94,0	5	440	12,90
330.1119	11,9	151,0	101,0	5	440	12,90
330.1120	12,0	151,0	101,0	5	440	14,90
330.1121	12,1	151,0	101,0	5	490	14,90
330.1122	12,2	151,0	101,0	5	490	14,90
330.1123	12,3	151,0	101,0	5	490	14,90
330.1124	12,4	151,0	101,0	5	490	14,90
330.1125	12,5	151,0	101,0	5	490	16,50
330.1126	12,6	151,0	101,0	5	515	16,50
330.1127	12,7	151,0	101,0	5	515	16,50
330.1128	12,8	151,0	101,0	5	515	16,50
330.1129	12,9	151,0	101,0	5	515	16,50
330.1130	13,0	151,0	101,0	5	515	17,50
330.1135	13,5	160,0	108,0	1	110	5,50
330.1140	14,0	160,0	108,0	1	115	5,50
330.1145	14,5	169,0	114,0	1	120	6,50
330.1150	15,0	169,0	114,0	1	125	6,50
330.1155	15,5	178,0	120,0	1	130	6,50
330.1160	16,0	178,0	120,0	1	135	7,50
330.1165	16,5	184,0	125,0	1	140	8,50
330.1170	17,0	184,0	125,0	1	145	8,50
330.1175	17,5	191,0	130,0	1	150	8,50
330.1180	18,0	191,0	130,0	1	155	8,50
330.1185	18,5	198,0	135,0	1	160	11,90
330.1190	19,0	198,0	135,0	1	165	10,90
330.1195	19,5	205,0	140,0	1	170	9,90
330.1200	20,0	205,0	140,0	1	175	10,90

HSS-R Twist drill set in metal case

- High strength hinge
- DIN 338 Typ N
- Right hand cutting
- Relieved cone has a ground point
- 118° pointed angle
- 20 - 30° spiral angle
- Black, tempered surface
- High performance steel

Ideally suitable in steel, cast steel and high and low alloyed steel up to 900 N/mm² tensile, bronze, brass, brushed aluminum alloy, graphite, nickel silver, sintered iron, malleable tempered and cast iron.



		€
330.1610 19 pcs	1,0 - 1,5 - 2,0 - 2,5 - 3,0 - 3,5 - 4,0 - 4,5 - 5,0 - 5,5 - 6,0 - 6,5 - 7,0 - 7,5 - 8,0 - 8,5 - 9,0 - 9,5 - 10,0 mm	0,60 17,50

HSS-R Twist drill set in plastic case

- Stackable for storage
- With integral clasp
- High strength hinge
- DIN 338 Typ N
- Right hand cutting
- Relieved cone has a ground point
- 118° pointed angle
- 20 - 30° spiral angle
- Black, tempered surface
- High performance steel

Ideally suitable in steel, cast steel and high and low alloyed steel up to 900 N/mm² tensile, bronze, brass, brushed aluminum alloy, graphite, nickel silver, sintered iron, malleable tempered and cast iron.



		€
330.1620 19 pcs	1,0 - 1,5 - 2,0 - 2,5 - 3,0 - 3,5 - 4,0 - 4,5 - 5,0 - 5,5 - 6,0 - 6,5 - 7,0 - 7,5 - 8,0 - 8,5 - 9,0 - 9,5 - 10,0 mm	0,60 22,50

HSS-R Twist drill set in metal case

- High strength hinge
- DIN 338 Typ N
- Right hand cutting
- Relieved cone has a ground point
- 118° pointed angle
- 20 - 30° spiral angle
- Black, tempered surface
- High performance steel

Ideally suitable in steel, cast steel and high and low alloyed steel up to 900 N/mm² tensile, bronze, brass, brushed aluminum alloy, graphite, nickel silver, sintered iron, malleable tempered and cast iron.



		€
330.1613 25 pcs	1,0 - 1,5 - 2,0 - 2,5 - 3,0 - 3,5 - 4,0 - 4,5 - 5,0 - 5,5 - 6,0 - 6,5 - 7,0 - 7,5 - 8,0 - 8,5 - 9,0 - 9,5 - 10,0 - 10,5 - 11,0 - 11,5 - 12,0 - 12,5 - 13,0 mm	1,30 33,50

HSS-R Twist drill set in plastic case

- Stackable for storage
- With integral clasp
- High strength hinge
- DIN 338 Typ N
- Right hand cutting
- Relieved cone has a ground point
- 118° pointed angle
- 20 - 30° spiral angle
- Black, tempered surface
- High performance steel

Ideally suitable in steel, cast steel and high and low alloyed steel up to 900 N/mm² tensile, bronze, brass, brushed aluminum alloy, graphite, nickel silver, sintered iron, malleable tempered and cast iron.



		€
330.1623 25 pcs	1,0 - 1,5 - 2,0 - 2,5 - 3,0 - 3,5 - 4,0 - 4,5 - 5,0 - 5,5 - 6,0 - 6,5 - 7,0 - 7,5 - 8,0 - 8,5 - 9,0 - 9,5 - 10,0 - 10,5 - 11,0 - 11,5 - 12,0 - 12,5 - 13,0 mm	3,35 38,50

HSS-R Twist drill set in metal case

- With integral clasp
- High strength hinge
- DIN 338 Typ N
- Right hand cutting
- Relieved cone has a ground point
- 118° pointed angle
- 20 - 30° spiral angle
- Black, tempered surface
- High performance steel

Ideally suitable in steel, cast steel and high and low alloyed steel up to 900 N/mm² tensile, bronze, brass, brushed aluminum alloy, graphite, nickel silver, sintered iron, malleable tempered and cast iron.



		€
330.1640 170 pcs	per 10 x: 1,0 - 1,5 - 2,0 - 2,5 - 3,0 - 3,5 - 4,0 - 4,5 - 5,0 - 5,5 - 6,0 - 6,5 - 7,0 - 7,5 - 8,0 per 5 x: 8,5 - 9,0 - 9,5 - 10,0 mm	4,15 117,90

	D mm	L1 mm	L2 mm	Content		€
330.7049	4,9	132,0	87,0	10	145	26,90
330.7050	5,0	132,0	87,0	10	150	25,90
330.7051	5,1	132,0	87,0	10	150	35,50
330.7052	5,2	132,0	87,0	10	160	34,50
330.7053	5,3	132,0	87,0	10	170	35,50
330.7054	5,4	139,0	91,0	10	190	35,50
330.7055	5,5	139,0	91,0	10	195	34,50
330.7056	5,6	139,0	91,0	10	200	38,50
330.7057	5,7	139,0	91,0	10	205	38,50
330.7058	5,8	139,0	91,0	10	210	38,50
330.7059	5,9	139,0	91,0	10	220	40,90
330.7060	6,0	139,0	91,0	10	225	38,50
330.7061	6,1	148,0	97,0	10	255	42,90
330.7062	6,2	148,0	97,0	10	260	42,90
330.7063	6,3	148,0	97,0	10	265	44,90
330.7064	6,4	148,0	97,0	10	270	44,90
330.7065	6,5	148,0	97,0	10	270	43,90
330.7066	6,6	148,0	97,0	10	275	53,50
330.7067	6,7	148,0	97,0	10	275	53,50
330.7068	6,8	156,0	102,0	10	360	53,50
330.7069	6,9	156,0	102,0	10	370	53,50
330.7070	7,0	156,0	102,0	10	375	51,50
330.7071	7,1	156,0	102,0	10	380	63,50
330.7072	7,2	156,0	102,0	10	380	63,50
330.7073	7,3	156,0	102,0	10	385	63,50
330.7074	7,4	156,0	102,0	10	390	63,50
330.7075	7,5	156,0	102,0	10	390	63,50
330.7076	7,6	165,0	109,0	10	480	80,50
330.7077	7,7	165,0	109,0	10	485	80,50
330.7078	7,8	165,0	109,0	10	485	80,50
330.7079	7,9	165,0	109,0	10	490	80,50
330.7080	8,0	165,0	109,0	10	495	80,50
330.7081	8,1	165,0	109,0	10	500	85,50
330.7082	8,2	165,0	109,0	10	505	85,50
330.7083	8,3	165,0	109,0	10	510	85,50
330.7084	8,4	165,0	109,0	10	520	85,50
330.7085	8,5	165,0	109,0	10	525	85,50
330.7086	8,6	175,0	115,0	10	620	98,50
330.7087	8,7	175,0	115,0	10	630	98,50
330.7088	8,8	175,0	115,0	10	635	102,90
330.7089	8,9	175,0	115,0	10	640	102,90
330.7090	9,0	175,0	115,0	10	645	102,90
330.7091	9,1	175,0	115,0	10	660	106,90
330.7092	9,2	175,0	115,0	10	670	106,90
330.7093	9,3	175,0	115,0	10	680	106,90
330.7094	9,4	175,0	115,0	10	690	106,90
330.7095	9,5	175,0	115,0	10	720	106,90
330.7096	9,6	184,0	121,0	10	800	133,90
330.7097	9,7	184,0	121,0	10	810	133,90
330.7098	9,8	184,0	121,0	10	815	133,90
330.7099	9,9	184,0	121,0	10	820	128,50
330.7100	10,0	184,0	121,0	10	825	133,90
330.7105	10,5	184,0	121,0	5	450	72,90
330.7110	11,0	195,0	128,0	5	525	83,50
330.7115	11,5	195,0	128,0	5	575	92,50
330.7120	12,0	205,0	134,0	5	660	100,50
330.7125	12,5	205,0	134,0	5	735	112,50
330.7130	13,0	205,0	134,0	5	765	117,90

HSS-G Twist drill set in metal case

- High strength hinge
- DIN 338 Typ N
- Right hand cutting
- Relieved cone has a ground point
- Cutting edge has thinning point
- 118° pointed angle
- 20 - 30° spiral angle
- High concentricity accuracy
- Surface without discolouration
- High performance steel

Ideally suitable in steel, cast steel and high and low alloyed steel up to 900 N/mm² tensile, bronze, brass, brushed aluminum alloy, graphite, nickel silver, sintered iron, malleable tempered and cast iron.



				€
330.2610	19 pcs	1,0 - 1,5 - 2,0 - 2,5 - 3,0 - 3,5 - 4,0 - 4,5 - 5,0 - 5,5 - 6,0 - 6,5 - 7,0 - 7,5 - 8,0 - 8,5 - 9,0 - 9,5 - 10,0 mm	0,60	48,50

HSS-G Twist drill set in metal case

- High strength hinge
- DIN 338 Typ N
- Right hand cutting
- Relieved cone has a ground point
- Cutting edge has thinning point
- 118° pointed angle
- 20 - 30° spiral angle
- High concentricity accuracy
- Surface without discolouration
- High performance steel

Ideally suitable in steel cast steel and high and low alloyed steel up to 900 N/mm² tensile, bronze, brass, brushed aluminum alloy, graphite, nickel silver, sintered iron, malleable tempered and cast iron.



				€
330.2613	25 pcs	1,0 - 1,5 - 2,0 - 2,5 - 3,0 - 3,5 - 4,0 - 4,5 - 5,0 - 5,5 - 6,0 - 6,5 - 7,0 - 7,5 - 8,0 - 8,5 - 9,0 - 9,5 - 10,0 - 10,5 - 11,0 - 11,5 - 12,0 - 12,5 - 13,0 mm	1,30	112,50

HSS-G Twist drill set in plastic case

- Stackable for storage
- With integral clasp
- High strength hinge
- DIN 338 Typ N
- Right hand cutting
- Relieved cone has a ground point
- Cutting edge has thinning point
- 118° pointed angle
- 20 - 30° spiral angle
- High concentricity accuracy
- Surface without discolouration
- High performance steel

Ideally suitable in steel, cast steel and high and low alloyed steel up to 900 N/mm² tensile, bronze, brass, brushed aluminum alloy, graphite, nickel silver, sintered iron, malleable tempered and cast iron.



				€
330.2620	19 pcs	1,0 - 1,5 - 2,0 - 2,5 - 3,0 - 3,5 - 4,0 - 4,5 - 5,0 - 5,5 - 6,0 - 6,5 - 7,0 - 7,5 - 8,0 - 8,5 - 9,0 - 9,5 - 10,0 mm	0,60	54,50

HSS-G Twist drill set in plastic case

- Stackable for storage
- With integral clasp
- High strength hinge
- DIN 338 Typ N
- Right hand cutting
- Relieved cone has a ground point
- Cutting edge has thinning point
- 118° pointed angle
- 20 - 30° spiral angle
- High concentricity accuracy
- Surface without discolouration
- High performance steel

Ideally suitable in steel, cast steel and high and low alloyed steel up to 900 N/mm² tensile, bronze, brass, brushed aluminum alloy, graphite, nickel silver, sintered iron, malleable tempered and cast iron.



				€
330.2623	25 pcs	1,0 - 1,5 - 2,0 - 2,5 - 3,0 - 3,5 - 4,0 - 4,5 - 5,0 - 5,5 - 6,0 - 6,5 - 7,0 - 7,5 - 8,0 - 8,5 - 9,0 - 9,5 - 10,0 - 10,5 - 11,0 - 11,5 - 12,0 - 12,5 - 13,0 mm	1,30	128,50



HSS-G Twist drill set in metal case

- High strength hinge
- DIN 338 Typ N
- Right hand cutting
- Relieved cone has a ground point
- Cutting edge has thinning point
- 130° pointed angle
- 20 - 30° spiral angle
- High heat hardness constancy
- For heavy loading
- TIN coated surface
- High performance steel

Ideally suitable in steel, cast steel and high and low alloyed steel up to 900 N/mm² tensile, bronze, brass, brushed aluminum alloy, graphite, nickel silver, sintered iron malleable tempered and cast iron.



		kg	€
330.4610	19 pcs 1,0 - 1,5 - 2,0 - 2,5 - 3,0 - 3,5 - 4,0 - 4,5 - 5,0 - 5,5 - 6,0 - 6,5 - 7,0 - 7,5 - 8,0 - 8,5 - 9,0 - 9,5 - 10,0 mm	0,66	49,50

HSS-G Twist drill set in metal case

- High strength hinge
- DIN 338 Typ N
- Right hand cutting
- Relieved cone has a ground point
- Cutting edge has thinning point
- 130° pointed angle
- 20 - 30° spiral angle
- High heat hardness constancy
- For heavy loading
- TIN coated surface
- High performance steel

Ideally suitable in steel, cast steel and high and low alloyed steel up to 900 N/mm² tensile, bronze, brass, brushed aluminum alloy, graphite, nickel silver, sintered iron malleable tempered and cast iron.



		kg	€
330.4613	25 pcs 1,0 - 1,5 - 2,0 - 2,5 - 3,0 - 3,5 - 4,0 - 4,5 - 5,0 - 5,5 - 6,0 - 6,5 - 7,0 - 7,5 - 8,0 - 8,5 - 9,0 - 9,5 - 10,0 - 10,5 - 11,0 - 11,5 - 12,0 - 12,5 - 13,0 mm	1,36	106,90

HSS-TiN Twist drill set in plastic case

- Stackable for storage
- With integral clasp
- High strength hinge
- DIN 338 Typ N
- Right hand cutting
- Relieved cone has a ground point
- Cutting edge has thinning point
- 130° pointed angle
- 20 - 30° spiral angle
- High heat hardness constancy
- For heavy loading
- TIN coated surface
- High performance steel

Ideally suitable in steel, cast steel and high and low alloyed steel up to 900 N/mm² tensile, bronze, brass, brushed aluminum alloy, graphite, nickel silver, sintered iron malleable tempered and cast iron.



		kg	€
330.4620	19 pcs 1,0 - 1,5 - 2,0 - 2,5 - 3,0 - 3,5 - 4,0 - 4,5 - 5,0 - 5,5 - 6,0 - 6,5 - 7,0 - 7,5 - 8,0 - 8,5 - 9,0 - 9,5 - 10,0 mm	0,66	77,50

HSS-TiN Twist drill set in plastic case

- Stackable for storage
- With integral clasp
- High strength hinge
- DIN 338 Typ N
- Right hand cutting
- Relieved cone has a ground point
- Cutting edge has thinning point
- 130° pointed angle
- 20 - 30° spiral angle
- High heat hardness constancy
- For heavy loading
- TIN coated surface
- High performance steel

Ideally suitable in steel, cast steel and high and low alloyed steel up to 900 N/mm² tensile, bronze, brass, brushed aluminum alloy, graphite, nickel silver, sintered iron malleable tempered and cast iron.



		kg	€
330.4623	25 pcs 1,0 - 1,5 - 2,0 - 2,5 - 3,0 - 3,5 - 4,0 - 4,5 - 5,0 - 5,5 - 6,0 - 6,5 - 7,0 - 7,5 - 8,0 - 8,5 - 9,0 - 9,5 - 10,0 - 10,5 - 11,0 - 11,5 - 12,0 - 12,5 - 13,0 mm	1,36	117,90

CENTRE DRILLS

HSS Centre drill

- DIN 333 form A
- Right hand cutting
- 60° centre angle
- 120° pointed angle
- For production of center borings
- Surface without discolouration
- High performance steel

Ideally suited for production of center borings according to DIN 332 form A.

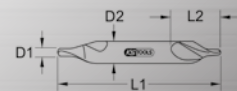

	D1 mm	D2 mm	L1 mm	L2 mm	Content	kg	€
330.1201	1,00	3,15	32,0	7,3	1	10	4,50
330.1202	1,50	4,00	36,0	9,3	1	10	6,50
330.1203	2,00	5,00	40,0	11,5	1	10	9,90
330.1204	2,50	6,30	46,0	15,4	1	20	14,90
330.1205	3,15	8,00	51,0	18,0	1	20	24,90
330.1206	4,00	10,00	56,0	20,0	1	22	38,50
330.1207	5,00	12,50	64,0	22,0	1	30	44,90
330.1208	6,30	15,00	72,0	30,0	1	30	50,50

HSS Centre drill

- DIN 333 form R
- Right hand cutting
- 60° centre angle
- 120° pointed angle
- For production of center borings
- Surface without discolouration
- High performance steel

Ideally suited for production of center borings according to DIN 332 form R.

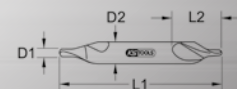

	D1 mm	D2 mm	L1 mm	L2 mm	Content	kg	€
330.1211	1,00	3,15	32,0	7,3	1	10	5,50
330.1212	1,50	4,00	36,0	9,3	1	10	7,50
330.1213	2,00	5,00	40,0	11,5	1	10	10,90
330.1214	2,50	6,30	46,0	15,4	1	20	20,50
330.1215	3,15	8,00	51,0	18,0	1	20	28,90
330.1216	4,00	10,00	56,0	20,0	1	22	40,90
330.1217	5,00	12,50	64,0	22,0	1	30	47,50
330.1218	6,30	15,00	72,0	30,0	1	30	51,50

SPOT WELD DRILLS

HSS Spot weld cutter

- Right hand cutting
- Interchangeable crowns
- Milling machine depth adjustable
- For efficient and fast working
- For loosening of spot welds
- No deformation of the sheet metal
- Special high performance steel

Ideally suitable with pneumatic drill, electric drill and rechargeable battery drill.

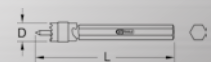

	D mm	D	L mm	Replacement crowns	Center point	Content	kg	€
332.0951	8,0	5/16	72,0	332.0952	332.0955	1	30	14,90
332.0953	10,0	3/8	72,0	332.0954	332.0955	1	30	14,90

HSS Spot weld cutter set

- Right hand cutting
- Interchangeable crowns
- Milling machine depth adjustable
- For efficient and fast working
- For loosening of spot welds
- No deformation of the sheet metal
- Special high performance steel

Ideally suitable with pneumatic drill, electric drill and rechargeable battery drill.



						€
332.0950	2 pcs	8 - 10 mm		100		27,90

HSSE TiCN Spot weld drill

- Right hand cutting
- Centre tip has a ground point
- Accurate polished
- For burr free drilling without using a centre punch
- For the drilling of welding points
- TiCN coated surface
- High performance steel

Ideally suited in a hand drilling machine.
For drilling of plastic sheet, copper, zinc, aluminum, brass and steel sheet.



	D mm	L1 mm	L2 mm	Content		€
332.0308	8,0	80,0	30,0	1	20	17,50
332.0310	10,0	90,0	35,0	1	40	22,50

HSSE TiN Spot weld drill

- Right hand cutting
- Centre tip has a ground point
- Accurate polished
- For burr free drilling without using a centre punch
- For the drilling of welding points
- TiN coated surface
- High performance steel

Ideally suited in a pneumatic drill and vario milling machine

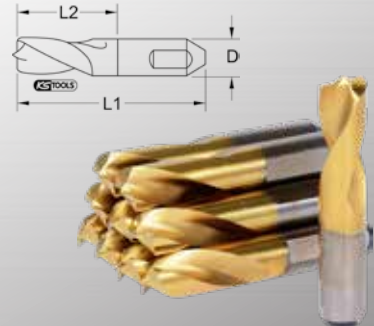

	D mm	L1 mm	L2 mm	Content		€
332.0809	8,0	44,0	23,0	10	134	144,50

HSSE Spot weld drill

- Right hand cutting
- Centre tip has a ground point
- Accurate polished
- For burr free drilling without using a centre punch
- For the drilling of welding points
- Surface without discolouration
- High performance steel

Ideally suited in a hand drilling machine.
For drilling of plastic sheet, copper, zinc, aluminum, brass and steel sheet.

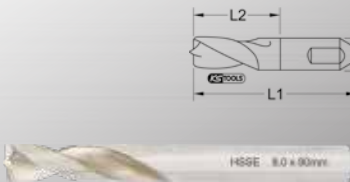

	D mm	L1 mm	L2 mm	Content		€
332.0106	6,0	70,0	25,0	1	10	10,90
332.0108	8,0	80,0	30,0	1	20	11,90
332.0110	10,0	90,0	35,0	1	40	16,50

HSS Spot weld drill

- Right hand cutting
- Centre tip has a ground point
- Accurate polished
- For burr free drilling without using a centre punch
- For the drilling of welding points
- TiCN coated surface
- High performance steel

Ideally suited in a pneumatic drill and vario milling machine.

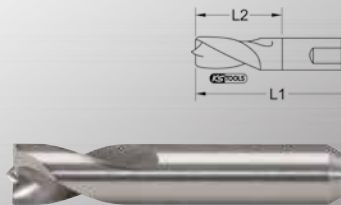

	D mm	L1 mm	L2 mm	Content		€
332.0408	6,5	44,0	15,0	1	10	17,50
332.0708	8,0	44,0	15,0	1	10	17,50

HSSE TiCN Spot weld drill

- Right hand cutting
- Centre tip has a ground point
- Accurate polished
- For burr free drilling without using a centre punch
- For the drilling of welding points
- TiCN coated surface
- High performance steel

Ideally suited in a pneumatic drill and vario milling machine.

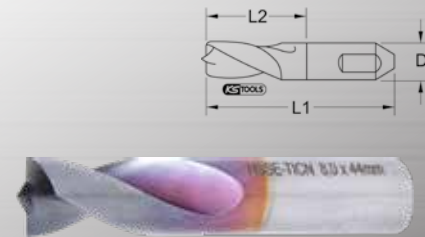

	D mm	L1 mm	L2 mm	Content		€
332.0608	8,0	44,0	15,0	1	10	21,50

HSSE TiN Spot weld drill

- Right hand cutting
- Centre tip has a ground point
- Accurate polished
- For burr free drilling without using a centre punch
- For the drilling of welding points
- TiN coated surface
- High performance steel

Ideally suited in a hand drilling machine.
For drilling of plastic sheet, copper, zinc, aluminum, brass and steel sheet.



	D mm	L1 mm	L2 mm	Content		€
332.0206	6,0	70,0	25,0	1	10	13,90
332.0208	8,0	80,0	30,0	1	20	13,90
332.0210	10,0	90,0	35,0	1	40	18,50

HSSE TiN Spot weld drill

- Right hand cutting
- Centre tip has a ground point
- Accurate polished
- For burr free drilling without using a centre punch
- For the drilling of welding points
- TiN coated surface
- High performance steel

Ideally suited in a pneumatic drill and vario milling machine.



	D mm	L1 mm	L2 mm	Content		€
332.0508	6,5	44,0	15,0	1	10	17,50
332.0808	8,0	44,0	15,0	1	10	17,50

HSSE Double ended spot weld drill

- Right hand cutting
- Relieved cone has a ground point
- Cutting edge has thinning point
- 135° pointed angle
- Dual-sided adjustment
- Extra short and durable
- For thin walled materials
- Surface without discolouration
- High performance steel

Ideally suitable in steel, cast steel and high and low alloyed steel up to 900 N/mm² tensile, bronze, brass, brushed aluminum alloy, graphite, nickel silver, sintered iron, pressure-, malleable- and cast iron

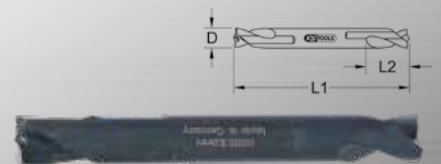

	D mm	L1 mm	L2 mm	Content		€
332.0908	8,0	70,0	16,3	1	20	28,90

HSS Double ended spot weld drill set

- Right hand cutting
- Relieved cone has a ground point
- Cutting edge has thinning point
- 135° pointed angle
- Dual-sided adjustment
- Extra short and durable
- For thin walled materials
- Surface without discolouration
- High performance steel

Ideally suitable in steel, cast steel and high and low alloyed steel up to 900 N/mm² tensile, bronze, brass, brushed aluminum alloy, graphite, nickel silver, sintered iron, pressure-, malleable- and cast iron



Item No.	Content	Weight (g)	Price (€)
332.0938	3 pcs 3 x 332.0908	70	92,50

Carbide spot weld drill

- Right hand cutting
- Highest stability under load
- Double edged
- Welded carbide head
- Especially temperature resistance up to max. 1100°C
- High performance carbide
- Suitable for high strength car body panels

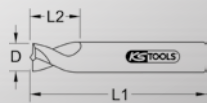

D mm	L1 mm	L2 mm	Content	Weight (g)	Price (€)
515.1305	8,0	44,0	1	22	68,50
515.1308	10,0	44,0	1	25	82,50

MILLING DRILLS

HSS Milling drill

- Right hand cutting
- Relieved cone has a ground point
- 118° pointed angle
- Suitable for thin walled material
- Surface without discolouration
- Special high performance steel

Ideally suitable for boring and milling machines thin walled materials, plastic, wood and sheet metal.

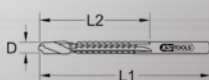

D mm	L1 mm	L2 mm	Content	Weight (g)	Price (€)
332.0330	6,0	90,0	1	25	5,50
332.0331	8,0	90,0	1	30	6,50

HSS TiN Milling drill

- Right hand cutting
- Relieved cone has a ground point
- 118° pointed angle
- Suitable for thin walled material
- TiN coated surface
- Special high performance steel

Ideally suitable for boring and milling machines thin walled materials, plastic, wood and sheet metal.

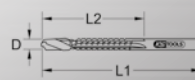

D mm	L1 mm	L2 mm	Content	Weight (g)	Price (€)
332.0332	6,0	90,0	1	25	5,50
332.0333	8,0	90,0	1	30	8,50

HSS CONE CUTTERS

HSS Cone cutter bit

- Point thinning according to DIN 1412 C
- Cutting edge has thinning point
- Right hand cutting
- 118° pointed angle
- 20 - 30° cone angle
- With 1/4" external hexagon drive adaptor to DIN 3126 - C6,3
- Absolute smooth operation
- High cutting achievement
- Surface without discolouration
- High performance steel



Ø mm	D1 mm	D2 mm	D3 mm	L1 mm	L2 mm	Content	Weight (g)	Price (€)
336.0031	5,0 - 22,0	20,0	5,0	6,4	78,0	1	65	34,50

HSS Cone cutter spiral grooved

- Point thinning according to DIN 1412 C
- Right hand cutting
- 118° pointed angle
- 20° cone angle
- Spiral form flute
- Three sided clamping surface on the shaft
- Absolute smooth operation
- Surface without discolouration
- High performance steel

Is suitable for use in all current industrial metals. Such as alloyed and non alloyed sheet metals up to 4.0 mm, NE metal and plastic. The spiral chip groove formed means that drilling is absolutely quiet, whilst the forming ensures the best cut achievement.

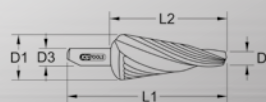

Ø mm	D1 mm	D2 mm	D3 mm	L1 mm	L2 mm	Content	Weight (g)	Price (€)
336.0024	4,0 - 14,0	14,0	4,0	6,0	58,0	1	20	26,90
336.0025	5,0 - 20,0	20,0	5,0	8,0	71,0	1	56	39,50
336.0026	5,0 - 31,0	31,0	5,0	10,0	103,0	1	170	86,90

HSS Cone cutter

- Point thinning according to DIN 1412 C
- Cutting edge has thinning point
- Right hand cutting
- 118° pointed angle
- 20 - 30° cone angle
- Absolute smooth operation
- High cutting achievement
- Surface without discolouration
- High performance steel

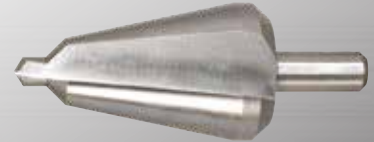
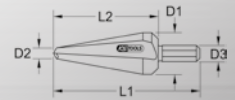

Item No.	Ø mm	D1 mm	D2 mm	D3 mm	L1 mm	L2 mm	Content	Weight (g)	Price (€)
336.0001	3,0 - 14,0	14,0	3,0	6,0	58,0	38,0	1	20	16,50
336.0002	5,0 - 20,0	20,0	5,0	8,0	71,0	51,0	1	50	29,90
336.0003	16,0 - 30,5	30,5	16,0	9,0	76,0	54,0	1	120	51,50
336.0004	24,0 - 40,0	40,0	24,0	10,0	89,0	65,0	1	270	95,50
336.0005	36,0 - 50,0	50,0	36,0	12,0	97,0	71,0	1	490	160,50
336.0006	40,0 - 61,0	61,0	40,0	13,0	103,0	73,0	1	510	240,90
336.0007	5,0 - 25,4	25,4	5,0	10,0	87,0	67,0	1	100	49,50
336.0008	4,0 - 30,0	30,0	4,0	9,0	103,0	83,0	1	150	69,50
336.0009	5,0 - 22,5	22,5	5,0	8,0	79,0	59,0	1	90	40,90

HSS Cone cutter set in metal case

- High strength hinge
- Point thinning according to DIN 1412 C
- Cutting edge has thinning point
- Right hand cutting
- 118° pointed angle
- 20 - 30° cone angle
- Absolute smooth operation
- High cutting achievement
- Surface without discolouration
- High performance steel



Item No.	Content	Weight (g)	Price (€)
336.0503	4 pcs 3 - 14 mm - 5 - 20 mm - 16 - 30,5 mm	590	128,50



HSS Cone cutter set in plastic case

- Stackable for storage
- With integral clasp
- High strength hinge
- Point thinning according to DIN 1412 C
- Cutting edge has thinning point
- Right hand cutting
- 118° pointed angle
- 20 - 30° cone angle
- Absolute smooth operation
- High cutting achievement
- Surface without discolouration
- High performance steel



336.0533	4 pcs	3 - 14 mm - 5 - 20 mm - 16 - 30,5 mm	590	€	133,90
----------	-------	--------------------------------------	-----	---	--------

HSS Co Cone cutter set in plastic case

- Stackable for storage
- With integral clasp
- High strength hinge
- Point thinning according to DIN 1412 C
- Cutting edge has thinning point
- Right hand cutting
- 118° pointed angle
- 20 - 30° cone angle
- Absolute smooth operation
- High cutting achievement
- Surface without discolouration
- High performance cobalt steel



336.0543	4 pcs	3 - 14 mm - 5 - 20 mm - 16 - 30,5 mm	590	€	133,90
----------	-------	--------------------------------------	-----	---	--------

HSS TiN Cone cutter set in metal case

- High strength hinge
- Point thinning according to DIN 1412 C
- Cutting edge has thinning point
- Right hand cutting
- 118° pointed angle
- 20 - 30° cone angle
- Absolute smooth operation
- High cutting achievement
- With TiN coated surface
- High performance steel



336.0523	4 pcs	3 - 14 mm - 5 - 20 mm - 16 - 30,5 mm	590	€	112,50
----------	-------	--------------------------------------	-----	---	--------

HSS CO CONE CUTTERS

HSS Co Cone cutter

- Point thinning according to DIN 1412 C
- Cutting edge has thinning point
- Right hand cutting
- 118° pointed angle
- 20 - 30° cone angle
- Absolute smooth operation
- High cutting achievement
- Surface without discolouration
- High performance cobalt steel

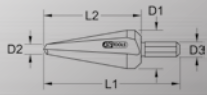

	Ø mm	D1 mm	D2 mm	D3 mm	L1 mm	L2 mm	Content	€
336.0011	3,0 - 20,0	14,0	3,0	6,0	58,0	38,0	1 20	20,50
336.0012	5,0 - 20,0	20,0	5,0	8,0	71,0	51,0	1 56	36,50
336.0013	16,0 - 30,5	30,5	16,0	9,0	76,0	54,0	1 120	77,50
336.0014	4,0 - 30,0	30,0	4,0	9,0	103,0	65,0	1 170	92,50

HSS TIN CONE CUTTERS

HSS TiN Cone cutter bit

- Point thinning according to DIN 1412 C
- Cutting edge has thinning point
- Right hand cutting
- 118° pointed angle
- 20 - 30° cone angle
- 1/4" external hexagon drive adaptor to DIN 3126 - C 6,3
- Absolute smooth operation
- High cutting achievement
- TiN coated surface
- High performance steel



336.0033	Ø mm	D1 mm	D2 mm	D3 mm	L1 mm	L2 mm	Content	€
336.0033	5,0 - 20,0	20,0	5,0	6,4	78,0	51,0	1 65	40,90

HSS TiN Cone cutter

- Point thinning according to DIN 1412 C
- Cutting edge has thinning point
- Right hand cutting
- 118° pointed angle
- 20 - 30° cone angle
- Absolute smooth operation
- High cutting achievement
- With TiN coated surface
- High performance steel

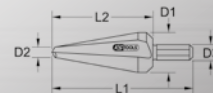

	Ø mm	D1 mm	D2 mm	D3 mm	L1 mm	L2 mm	Content	€
336.0015	3,0 - 14,0	14,0	3,0	6,0	58,0	38,0	1 20	18,50
336.0016	5,0 - 20,0	20,0	5,0	8,0	71,0	51,0	1 56	29,90
336.0017	16,0 - 30,5	30,5	16,0	9,0	76,0	54,0	1 120	57,90
336.0018	24,0 - 40,0	40,0	24,0	10,0	89,0	65,0	1 259	99,50
336.0019	36,0 - 50,0	50,0	36,0	12,0	97,0	71,0	1 480	160,50
336.0020	40,0 - 61,0	61,0	40,0	13,0	103,0	73,0	1 605	246,50
336.0021	5,0 - 25,4	25,4	5,0	10,0	87,0	67,0	1 150	50,50
336.0022	4,0 - 30,0	30,0	4,0	9,0	103,0	83,0	1 170	71,90
336.0023	5,0 - 22,5	22,5	5,0	8,0	79,0	59,0	1 180	38,50

HSS Co Cone cutter set in metal case

- High strength hinge
- Point thinning according to DIN 1412 C
- Cutting edge has thinning point
- Right hand cutting
- 118° pointed angle
- 20 - 30° cone angle
- Absolute smooth operation
- High cutting achievement
- Surface without discolouration
- High performance cobalt steel



336.0513	4 pcs	3 - 14 mm - 5 - 20 mm - 16 - 30,5 mm	590	€	139,50
----------	-------	--------------------------------------	-----	---	--------

HSS TiN Cone cutter set in plastic case

- Stackable for storage
- With integral clasp
- High strength hinge
- Point thinning according to DIN 1412 C
- Cutting edge has thinning point
- Right hand cutting
- 118° pointed angle
- 20 - 30° cone angle
- Absolute smooth operation
- High cutting achievement
- With TiN coated surface
- High performance steel



336.0553	4 pcs	3 - 14 mm - 5 - 20 mm - 16 - 30,5 mm	590	€	144,50
----------	-------	--------------------------------------	-----	---	--------



HSS Co 5 Stepped drill set in metal case

- High strength hinge
- Point thinning according to DIN 1412 C
- Cutting edge has thinning point
- Right hand cutting
- Spiral grooved
- 118° pointed angle
- 90° stepped angle
- Absolute smooth operation
- High cutting achievement
- Surface without discolouration
- High performance cobalt steel

The cone simplifies the retracting through bored sheet metals. Higher feed especially in NE metals possible due to the slim cutting edge.

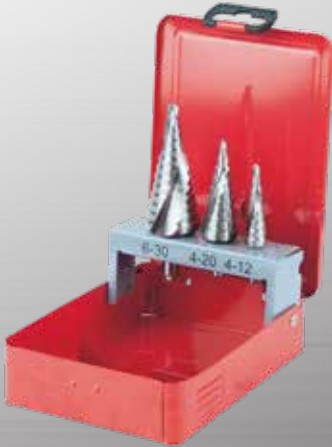

					€
330.2413	3 pcs	4 - 12 mm - 4 - 20 mm - 6 - 30 mm	600		181,90

HSS Co 5 Stepped drill set in plastic case

- Stackable for storage
- With integral clasp
- High strength hinge
- Point thinning according to DIN 1412 C
- Cutting edge has thinning point
- Right hand cutting
- Spiral grooved
- 118° pointed angle
- 90° stepped angle
- Absolute smooth operation
- High cutting achievement
- Surface without discolouration
- High performance cobalt steel

The cone simplifies the retracting through bored sheet metals. Higher feed especially in NE metals possible due to the slim cutting edge.



					€
330.2414	3 pcs	4 - 12 mm - 4 - 20 mm - 6 - 30 mm	600		181,90

HSS TiN STEPPED DRILLS

HSS TiN Stepped drill bit

- Point thinning according to DIN 1412 C
- Cutting edge has thinning point
- Right hand cutting
- Spiral grooved
- 118° pointed angle
- 90° stepped angle
- 1/4" external hexagon drive adaptor to DIN 3126 - C 6,3
- Absolute smooth operation
- High cutting achievement
- With TiN coated surface
- High performance steel

The cone simplifies the retracting through bored sheet metals. Breaking chips and swarf are taken away. The construction of the cutting edges and cold welded joint in the edges blunting is thereby prevented.

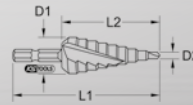

	Ø mm	D1 mm	D2 mm	L1 mm	L2 mm	No. stages	Content	€
330.2384	4,0-12,0	12,0	4,0	72,0	45,0	9	1 25	28,90
330.2385	4,0-20,0	20,0	4,0	81,0	54,0	9	1 85	38,50
330.2386	4,0-30,0	30,0	4,0	105,0	78,0	14	1 165	82,50

HSS TiN Stepped drill, extra short

- Point thinning according to DIN 1412 C
- Cutting edge has thinning point
- Right hand cutting
- Spiral grooved
- 118° pointed angle
- 90° stepped angle
- Absolute smooth operation
- High cutting achievement
- With TiN coated surface
- High performance steel

The cone simplifies the retracting through bored sheet metals. Breaking chips and swarf are taken away. The construction of the cutting edges and cold welded joint in the edges blunting is thereby prevented. Ideally suited for construction strength grade sheet metal up to 2.0 mm.

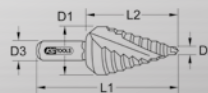

	Ø mm	D1 mm	D2 mm	D3 mm	L1 mm	L2 mm	No. stages	Content	€
330.2374	4 - 12	12,0	4,0	6,0	48,0	28,0	9	1 16	24,90
330.2375	4 - 20	20,0	4,0	8,0	58,0	38,0	9	1 42	36,50
330.2376	4 - 30	30,0	4,0	10,0	72,0	49,0	14	1 130	72,90

HSS TiN Stepped drill

- Point thinning according to DIN 1412 C
- Cutting edge has thinning point
- Right hand cutting
- Spiral grooved
- 118° pointed angle
- 90° stepped angle
- Absolute smooth operation
- High cutting achievement
- With TiN coated surface
- High performance steel

The cone simplifies the retracting through bored sheet metals. Higher feed especially in NE metals possible due to the slim cutting edge.

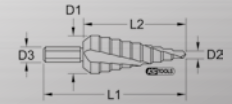

	Ø mm	D1 mm	D2 mm	D3 mm	L1 mm	L2 mm	No. stages	Content	€
330.2343	4 - 12	12,0	4,0	6,0	65,0	45,0	9	1 22	25,90
330.2344	4 - 20	20,0	4,0	8,0	75,0	55,0	9	1 60	36,50
330.2345	4 - 30	30,0	4,0	10,0	100,0	78,0	14	1 185	79,50
330.2346	6 - 30	30,0	6,0	10,0	95,0	73,0	13	1 205	78,50
330.2347	6 - 37	37,0	6,0	10,0	100,0	76,0	12	1 245	106,90
330.2348	6 - 38	38,0	6,0	10,0	100,0	76,0	12	1 260	113,50
330.2349	4 - 39	39,0	4,0	10,0	107,0	83,0	13	1 312	113,50
330.2350	6 - 40	40,0	6,0	13,0	105,0	81,0	16	1 455	133,90
330.2351	6 - 20	20,0	6,0	9,0	71,0	51,0	8	1 100	36,50
330.2352	4 - 22	22,0	4,0	10,0	76,0	56,0	10	1 85	44,90
330.2353	6 - 26,8	26,8	6,0	10,0	75,0	53,0	8	1 110	55,90
330.2354	6 - 32	32,0	6,0	10,0	75,0	53,0	8	1 102	75,90
330.2355	6 - 32	32,0	6,0	10,0	76,0	53,0	9	1 108	80,50
330.2356	5 - 28	28,0	5,0	9,0	69,0	47,0	7	1 86	57,90
330.2357	6 - 25	25,0	6,0	10,0	65,0	42,0	7	1 135	49,50
330.2358	6 - 30,5	30,5	6,0	10,0	80,0	57,0	9	1 150	79,50
330.2359	6,5 - 40,5	40,5	6,5	10,0	96,0	72,0	11	1 265	117,90
330.2360	6 - 36	36,0	6,0	10,0	82,0	57,0	11	1 255	104,90
330.2361	7 - 40,5	40,5	7,0	12,0	95,0	70,0	13	1 275	133,90
330.2362	4,8 - 10,7	10,7	4,8	6,0	54,0	34,0	5	1 27	22,50
330.2363	7 - 32,5	32,5	7,0	12,0	96,0	71,0	11	1 220	90,90

HSS TiN Stepped drill set in metal case

- High strength hinge
- Point thinning according to DIN 1412 C
- Cutting edge has thinning point
- Right hand cutting
- Spiral grooved
- 118° pointed angle
- 90° stepped angle
- Absolute smooth operation
- High cutting achievement
- With TiN coated surface
- High performance steel

The cone simplifies the retracting through bored sheet metals. Higher feed especially in NE metals possible due to the slim cutting edge.



					€
330.2423	3 pcs	4 - 12 mm - 4 - 20 mm - 6 - 30 mm	610		181,90

HSS TiN Stepped drill set in plastic case

- Stackable for storage
- With integral clasp
- High strength hinge
- Point thinning according to DIN 1412 C
- Cutting edge has thinning point
- Right hand cutting
- Spiral grooved
- 118° pointed angle
- 90° stepped angle
- Absolute smooth operation
- High cutting achievement
- With TiN coated surface
- High performance steel

The cone simplifies the retracting through bored sheet metals. Higher feed especially in NE metals possible due to the slim cutting edge.



330.2424	3 pcs	4 - 12 mm - 4 - 20 mm - 6 - 30 mm	610	€
				192,50

HSS Co Cone and deburrer 60°

- DIN 334 form C
- Right hand cutting
- 60° Countersink angle
- Cylindrical shaft
- Deep ground flutes
- Surface without discolouration
- High performance cobalt steel

Ideally suitable for deburring and countersinking in steel, non ferrous metals and light metals as well as chatter free countersinking.



	D1 mm	D2 mm	D3 mm	L mm	Content	g	€
336.0102	6,3	1,6	5,0	45,0	1	10	12,90
336.0103	8,0	2,0	6,0	50,0	1	12	14,90
336.0104	10,0	2,5	6,0	53,0	1	14	16,50
336.0105	12,5	3,2	8,0	56,0	1	24	18,50
336.0106	16,0	4,0	10,0	63,0	1	44	22,50
336.0107	20,0	5,0	10,0	67,0	1	50	26,90
336.0108	25,0	6,3	10,0	71,0	1	64	35,50
336.0109	31,5	10,0	12,0	76,0	1	78	54,50

HSS Co Cone and deburrer 75°

- Form C
- Right hand cutting
- 75° Countersink angle
- Cylindrical shaft
- Deep ground flutes
- Surface without discolouration
- High performance cobalt steel

Ideally suitable for deburring and countersinking in steel, non ferrous metals and light metals as well as chatter free countersinking.

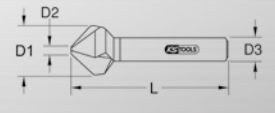

	D1 mm	D2 mm	D3 mm	L mm	Content	g	€
336.0110	6,3	1,6	5,0	45,0	1	10	12,90
336.0111	8,0	2,0	6,0	50,0	1	12	14,90
336.0112	10,0	2,5	6,0	53,0	1	14	16,50
336.0113	12,5	3,2	8,0	56,0	1	24	19,50
336.0114	16,0	4,0	10,0	63,0	1	44	23,50
336.0115	20,0	5,0	10,0	67,0	1	50	27,90
336.0116	25,0	6,3	10,0	71,0	1	64	37,50
336.0117	31,5	10,0	12,0	76,0	1	78	56,90

CONE - AND DEBURRING 60°

HSS Cone and deburrer 60°

- DIN 334 form C
- Right hand cutting
- 60° Countersink angle
- Cylindrical shaft
- Deep ground flutes
- Surface without discolouration
- High performance steel

Ideally suitable for deburring and countersinking in steel, non ferrous metals and light metals as well as chatter free countersinking.



	D1 mm	D2 mm	D3 mm	L mm	Content	g	€
336.0034	6,3	1,6	5,0	45,0	1	10	11,90
336.0035	8,0	2,0	6,0	50,0	1	12	12,90
336.0036	10,0	2,5	6,0	53,0	1	12	13,90
336.0037	12,5	3,2	8,0	56,0	1	24	17,50
336.0038	16,0	4,0	10,0	63,0	1	42	21,50
336.0039	20,0	5,0	10,0	67,0	1	50	25,90
336.0040	25,0	6,3	10,0	71,0	1	66	29,90
336.0041	31,5	10,0	12,0	76,0	1	78	43,90

CONE - AND DEBURRING 75°

HSS Cone and deburrer 75°

- Form C
- Right hand cutting
- 75° Countersink angle
- Cylindrical shaft
- Deep ground flutes
- Surface without discolouration
- High performance steel

Ideally suitable for deburring and countersinking in steel, non ferrous metals and light metals as well as chatter free countersinking.



	D1 mm	D2 mm	D3 mm	L mm	Content	g	€
336.0042	6,3	1,6	5,0	45,0	1	10	11,90
336.0043	8,0	2,0	6,0	50,0	1	12	12,90
336.0044	10,0	2,5	6,0	53,0	1	14	14,90
336.0045	12,5	3,2	8,0	56,0	1	24	17,50
336.0046	16,0	4,0	10,0	63,0	1	44	22,50
336.0047	20,0	5,0	10,0	67,0	1	50	25,90
336.0048	25,0	6,3	10,0	71,0	1	64	31,50
336.0049	31,5	10,0	12,0	76,0	1	78	44,90

CONE - AND DEBURRING 90°

HSS Cone and deburrer bit 90°

- Right hand cutting
- 90° Countersink angle
- 1/4" external hexagon drive adaptor to DIN 3126 - C 6,3
- Three cutting edges
- Surface without discolouration
- High performance steel

Ideally suitable for deburring and countersinking in steel, non ferrous metals and light metals as well as chatter free countersinking.

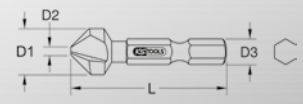

	D1 mm	D2 mm	D3 mm	L mm	Content	g	€
336.0274	6,3	1,0	6,4	45,0	1	10	12,90
336.0275	8,3	1,5	6,4	50,0	1	14	13,90
336.0276	10,4	2,0	6,4	50,0	1	15	14,90
336.0277	12,4	2,0	6,4	56,0	1	26	17,50
336.0278	16,5	2,5	6,4	60,0	1	36	21,50
336.0279	20,5	3,0	6,4	63,0	1	52	23,50

HSS Cone and deburrer 90°

- DIN 335 form C
- Right hand cutting
- 90° Countersink angle
- Three cutting edges
- Cylindrical shaft
- Deep ground flutes
- Surface without discolouration
- High performance steel

Ideally suitable for deburring and countersinking in steel, non ferrous metals and light metals as well as chatter free countersinking.



	D1 mm	D2 mm	D3 mm	L mm	Countersink DIN 74 AF	Countersink DIN 74 BF	Content	🔩	€
336.0050	4,3	1,3	4,0	40,0			1	9	11,90
336.0051	5,0	1,5	4,0	40,0	M2,5		1	9	11,90
336.0052	5,3	1,5	4,0	40,0			1	9	11,90
336.0053	5,8	1,5	5,0	45,0			1	10	11,90
336.0054	6,0	1,5	5,0	45,0	M3		1	10	11,90
336.0055	6,3	1,5	5,0	45,0		M3	1	10	10,90
336.0056	7,0	1,8	6,0	50,0	M3,5		1	13	11,90
336.0057	7,3	1,8	6,0	50,0			1	13	11,90
336.0058	8,0	2,0	6,0	50,0	M4		1	15	12,90
336.0059	8,3	2,0	6,0	50,0		M4	1	15	12,90
336.0060	9,4	2,2	6,0	50,0			1	18	13,90
336.0061	10,0	2,5	6,0	50,0	M5		1	20	13,90
336.0062	10,4	2,5	6,0	50,0		M5	1	20	13,90
336.0063	11,5	2,8	8,0	56,0	M6		1	26	16,50
336.0064	12,4	2,8	8,0	56,0		M6	1	26	16,50
336.0065	13,4	2,9	8,0	56,0			1	26	19,50
336.0066	15,0	3,2	10,0	60,0	M8		1	36	20,50
336.0067	16,5	3,2	10,0	60,0		M8	1	36	21,50
336.0068	19,0	3,5	10,0	63,0	M10		1	52	22,50
336.0069	20,5	3,5	10,0	63,0		M10	1	52	22,50
336.0070	23,0	3,8	10,0	67,0	M12		1	62	26,90
336.0071	25,0	3,8	10,0	67,0		M12	1	62	28,90
336.0072	26,0	3,9	12,0	71,0	M14		1	65	31,50
336.0073	28,0	4,0	12,0	71,0		M14	1	70	36,50
336.0074	30,0	4,1	12,0	71,0	M16		1	70	39,50
336.0075	31,0	4,2	12,0	71,0		M16	1	70	42,90

HSS Cone and deburrer set 90° in metal case

- High strength hinge
- DIN 335 form C
- Right hand cutting
- 90° Countersink angle
- Three cutting edges
- Cylindrical shaft
- Deep ground flutes
- Surface without discolouration
- High performance steel

Ideally suitable for deburring and countersinking in steel, non ferrous metals and light metals as well as chatter free countersinking.



	🔩	€
336.0406	6 pcs	104,90

HSS Cone and deburrer set 90° in plastic case

- Stackable for storage
- With integral clasp
- High strength hinge
- DIN 335 form C
- Right hand cutting
- 90° Countersink angle
- Three cutting edges
- Cylindrical shaft
- Deep ground flutes
- Surface without discolouration
- High performance steel

Ideally suitable for deburring and countersinking in steel, non ferrous metals and light metals as well as chatter free countersinking.



	🔩	€
336.0446	6 pcs	104,90

HSS Co Cone and deburrer bit 90°

- Right hand cutting
- 90° Countersink angle
- 1/4" external hexagon drive adaptor to DIN 3126 - C 6,3
- Three cutting edges
- Surface without discolouration
- High performance cobalt steel

Ideally suitable for deburring and countersinking in steel, non ferrous metals and light metals as well as chatter free countersinking.



	D1 mm	D2 mm	D3 mm	L mm	Content	🔩	€
336.0300	6,3	1,0	6,4	45,0	1	10	12,90
336.0301	8,3	1,5	6,4	50,0	1	14	14,90
336.0302	10,4	2,0	6,4	50,0	1	15	16,50
336.0303	12,4	2,0	6,4	56,0	1	26	19,50
336.0304	16,5	2,5	6,4	60,0	1	36	22,50
336.0305	20,5	3,0	6,4	63,0	1	52	27,90

HSS Co 5 Cone and deburrer 90°

- DIN 335 form C
- Right hand cutting
- 90° Countersink angle
- Three cutting edges
- Cylindrical shaft
- Deep ground flutes
- Surface without discolouration
- High performance cobalt steel

Ideally suitable for deburring and countersinking in steel, non ferrous metals and light metals as well as chatter free countersinking.



	D1 mm	D2 mm	D3 mm	L mm	Countersink DIN 74 AF	Countersink DIN 74 BF	Content	🔩	€
336.0118	4,3	1,3	4,0	40,0			1	9	12,90
336.0119	5,0	1,5	4,0	40,0	M2,5		1	9	11,90
336.0120	5,3	1,5	4,0	40,0			1	9	12,90
336.0121	5,8	1,5	5,0	45,0			1	10	12,90
336.0122	6,0	1,5	5,0	45,0	M3		1	10	12,90
336.0123	6,3	1,5	5,0	45,0		M3	1	10	12,90
336.0124	7,0	1,8	6,0	50,0	M3,5		1	13	12,90
336.0125	7,3	1,8	6,0	50,0			1	13	12,90
336.0126	8,0	2,0	6,0	50,0	M4		1	15	13,90
336.0127	8,3	2,0	6,0	50,0		M4	1	15	13,90
336.0128	9,4	2,2	6,0	50,0			1	18	16,50
336.0129	10,0	2,5	6,0	50,0	M5		1	20	16,50
336.0130	10,4	2,5	6,0	50,0		M5	1	20	14,90
336.0131	11,5	2,8	8,0	56,0	M6		1	26	19,50
336.0132	12,4	2,8	8,0	56,0		M6	1	26	18,50
336.0133	13,4	2,9	8,0	56,0			1	26	21,50
336.0134	15,0	3,2	10,0	60,0	M8		1	36	22,50
336.0135	16,5	3,2	10,0	60,0		M8	1	36	21,50
336.0136	19,0	3,5	10,0	63,0	M10		1	52	26,90
336.0137	20,5	3,5	10,0	63,0		M10	1	52	26,90
336.0138	23,0	3,8	10,0	67,0	M12		1	62	31,50
336.0139	25,0	3,8	10,0	67,0		M12	1	62	35,50
336.0140	26,0	3,9	12,0	71,0	M14		1	65	37,50
336.0141	28,0	4,0	12,0	71,0		M14	1	70	41,90
336.0142	30,0	4,1	12,0	71,0	M16		1	70	46,50
336.0143	31,0	4,2	12,0	71,0		M16	1	70	51,50

HSS Co 5 Cone and deburrer set 90° in metal case

- High strength hinge
- DIN 335 form C
- Right hand cutting
- 90° Countersink angle
- Three cutting edges
- Cylindrical shaft
- Deep ground flutes
- Surface without discolouration
- High performance cobalt steel

Ideally suitable for deburring and countersinking in steel, non ferrous metals and light metals as well as chatter free countersinking.



	🔩	€
336.0416	6 pcs	112,50

HSS Co 5 Cone and deburrer set 90° in plastic case

- Stackable for storage
- With integral clasp
- High strength hinge
- DIN 335 form C
- Right hand cutting
- 90° Countersink angle
- Three cutting edges
- Cylindrical shaft
- Deep ground flutes
- Surface without discolouration
- High performance cobalt steel

Ideally suitable for deburring and countersinking in steel, non ferrous metals and light metals as well as chatter free countersinking.



336.0456	6 pcs	6.3 - 8.3 - 10.4 - 12.4 - 16.5 - 20.5 mm	530	€
				117,90

HSS TiN Cone and deburrer 90°

- DIN 335 form C
- Right hand cutting
- 90° Countersink angle
- Three cutting edges
- Cylindrical shaft
- Deep ground flutes
- TiN coated surface
- High performance steel

Ideally suitable for deburring and countersinking in steel, non ferrous metals and light metals as well as chatter free countersinking.



	D1 mm	D2 mm	D3 mm	L mm	Countersink DIN 74 AF	Countersink DIN 74 BF	Content	g	€
336.0170	4,3	1,3	4,0	40,0			1	9	11,90
336.0171	5,0	1,5	4,0	40,0	M2,5		1	9	11,90
336.0172	5,3	1,5	4,0	40,0			1	9	11,90
336.0173	5,8	1,5	5,0	45,0			1	10	11,90
336.0174	6,0	1,5	5,0	45,0	M3		1	10	11,90
336.0175	6,3	1,5	5,0	45,0		M3	1	10	11,90
336.0176	7,0	1,8	6,0	50,0	M3,5		1	13	11,90
336.0177	7,3	1,8	6,0	50,0			1	13	12,90
336.0178	8,0	2,0	6,0	50,0	M4		1	15	13,90
336.0179	8,3	2,0	6,0	50,0		M4	1	15	12,90
336.0180	9,4	2,0	6,0	50,0			1	18	14,90
336.0181	1,0	2,5	6,0	50,0	M5		1	20	14,90
336.0182	10,4	2,5	6,0	50,0		M5	1	20	14,90
336.0183	11,5	2,8	8,0	56,0	M6		1	26	17,50
336.0184	12,4	2,8	8,0	56,0		M6	1	26	17,50
336.0185	13,4	2,9	8,0	56,0			1	26	20,50
336.0186	15,0	3,2	10,0	60,0	M8		1	36	21,50
336.0187	16,5	3,2	10,0	60,0		M8	1	36	21,50
336.0188	19,0	3,5	10,0	63,0	M10		1	52	24,90
336.0189	20,5	3,5	10,0	63,0		M10	1	52	25,90
336.0190	23,0	3,8	10,0	67,0	M12		1	62	27,90
336.0191	25,0	3,8	10,0	67,0		M12	1	62	31,50
336.0192	26,0	3,9	12,0	71,0	M14		1	65	33,50
336.0193	28,0	4,0	12,0	71,0		M14	1	70	40,90
336.0194	30,0	4,1	12,0	71,0	M16		1	70	40,90
336.0195	31,0	4,2	12,0	71,0		M16	1	70	42,90

HSS TiN Cone and deburrer set 90° in plastic case

- Stackable for storage
- With integral clasp
- High strength hinge
- DIN 335 form C
- Right hand cutting
- 90° Countersink angle
- Three cutting edges
- Cylindrical shaft
- Deep ground flutes
- TiN coated surface
- High performance steel

Ideally suitable for deburring and countersinking in steel, non ferrous metals and light metals as well as chatter free countersinking.



336.0466	6 pcs	6.3 - 8.3 - 10.4 - 12.4 - 16.5 - 20.5 mm	530	€
				117,90

HSS TiN Cone and deburrer bit 90°

- Right hand cutting
- 90° Countersink angle
- Three cutting edges
- 1/4" external hexagon drive adaptor to DIN 3126 - C 6,3
- TiN coated surface
- High performance steel

Ideally suitable for deburring and countersinking in steel, non ferrous metals and light metals as well as chatter free countersinking.



	D1 mm	D2 mm	D3 mm	L mm	Content	g	€
336.0326	6,3	1,0	6,4	45,0	1	10	12,90
336.0327	8,3	1,5	6,4	50,0	1	14	13,90
336.0328	10,4	2,0	6,4	50,0	1	15	16,50
336.0329	12,4	2,0	6,4	56,0	1	26	17,50
336.0330	16,5	2,5	6,4	60,0	1	36	23,50
336.0331	20,5	3,0	6,4	63,0	1	52	26,90

HSS TiN Cone and deburrer set 90° in metal case

- High strength hinge
- DIN 335 form C
- Right hand cutting
- 90° Countersink angle
- Three cutting edges
- Cylindrical shaft
- Deep ground flutes
- TiN coated surface
- High performance steel

Ideally suitable for deburring and countersinking in steel, non ferrous metals and light metals as well as chatter free countersinking.



336.0426	6 pcs	6.3 - 8.3 - 10.4 - 12.4 - 16.5 - 20.5 mm	530	€
				112,50

CONE - AND DEBURRING 120°

HSS Cone and deburrer 120°

- Form C
- Right hand cutting
- 120° Countersink angle
- Cylindrical shaft
- Deep ground flutes
- Surface without discolouration
- High performance steel

Ideally suitable for deburring and countersinking in steel, non ferrous metals and light metals as well as chatter free countersinking.



	D1 mm	D2 mm	D3 mm	L mm	Content	g	€
336.0076	6,3	1,5	5,0	45,0	1	14	11,90
336.0077	8,3	2,0	6,0	50,0	1	14	12,90
336.0078	10,4	2,5	6,0	50,0	1	20	14,90
336.0079	12,4	2,8	8,0	56,0	1	28	16,50
336.0080	16,5	3,2	10,0	60,0	1	46	20,50
336.0081	20,5	3,5	10,0	63,0	1	54	23,50
336.0082	25,0	3,8	10,0	67,0	1	62	29,90

HSS hand drill tap set M in plastic case

- Stackable for storage
- With integral clasp
- High strength hinge
- DIN 352
- Tolerance according to ISO 2 / 6H
- Right hand cutting
- Includes second and bottom tap
- For running and blind hole threads
- With hard metal centre
- Surface without discolouration
- High performance high speed steel
- Each size includes 1x second and bottom tap

Ideally usable in high and low alloyed steel up to 800 N/mm² stability, cast iron and NE metals.



Taper tap: ca. 5 - 6 cutting gears
Second tap: ca. 4 - 5 cutting gears
Bottom tap: ca. 2 - 3 cutting gears

		kg	€
336.0641	21 pcs M3 - M4 - M5 - M6 - M8 - M10 - M12	620	65,50

HSS tap and die set in metal case

- Universal set
- Straight forward hand thread cutting
- With adjustable tap wrench and die holder
- Includes taperproof drill, thread gauge and screwdriver
- High performance steel



		kg	€
331.0644	44 pcs HSS tap and die set in metal case	3,93	213,90
21 x	M3 - M4 - M5 - M6 - M8 - M10 - M12		
7 x	2,5 - 3,3 - 4,2 - 5 - 6,8 - 8,5 - 10,2 mm		
7 x	M3 - M4 - M5 - M6 - M8 - M10 - M12		
5 x	M3-M4 - M4,5-M6 - M7-M9 - M10-M11 - M12-M14		
2 x	M1-M10 - M3-M12		
1 x			
1 x			

HSS CO THREADED TAP

HSS Co slitting tap and die M

- DIN 352 form B
- Tolerance according to ISO 2 / 6H
- Right hand cutting
- Hard metal centre
- Metric thread
- Thread process by slicing the cutting edge
- Surface without discolouration
- High performance cobalt steel

Ideally usable in high and low alloyed steel up to 900 N/mm² stability, cast iron and NE metals.

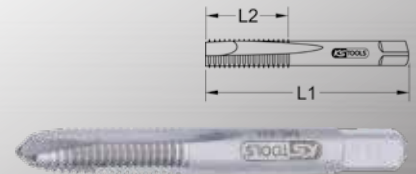

		mm	L1 mm	L2 mm	Content	kg	€
331.0223	M3 x 0,5	2,50	40,0	11,0	1	4	5,50
331.0224	M4 x 0,7	3,30	45,0	13,0	1	7	5,50
331.0225	M5 x 0,8	4,20	50,0	16,0	1	11	6,50
331.0226	M6 x 1,0	5,00	50,0	19,0	1	13	5,50
331.0228	M8 x 1,25	6,80	56,0	22,0	1	15	8,50
331.0230	M10 x 1,5	8,50	70,0	24,0	1	30	16,50
331.0232	M12 x 1,75	10,50	75,0	29,0	1	44	12,90

HSS Co hand drill tap set M

- DIN 352
- Tolerance according to ISO 2 / 6H
- Right hand cutting
- Includes second and bottom tap
- For running and blind hole threads
- With hard metal centre
- Surface without discolouration
- High performance cobalt steel

Ideally usable in high and low alloyed steel up to 900 N/mm² stability, cast iron and NE metals.

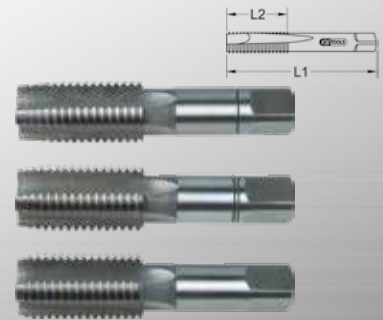

Taper tap: ca. 5 - 6 cutting gears
Second tap: ca. 4 - 5 cutting gears
Bottom tap: ca. 2 - 3 cutting gears

		mm	L1 mm	Individual taper tap	Individual second tap	Individual bottom tap	L2 mm	kg	€
331.2020	M2 x 0,4	1,60	36,0	331.2301	331.3321	331.3341	8,0	10	16,50
331.2025	M2,5 x 0,45	2,10	40,0	331.2302	331.3322	331.3342	9,0	12	16,50
331.2030	M3 x 0,5	2,50	40,0	331.2303	331.3323	331.3343	11,0	12	16,50
331.2035	M3,5 x 0,6	2,90	45,0	331.2304	331.3324	331.3344	13,0	18	16,50
331.2040	M4 x 0,7	3,30	45,0	331.2305	331.3325	331.3345	13,0	20	16,50
331.2050	M5 x 0,8	4,20	50,0	331.2306	331.3326	331.3346	16,0	34	18,50
331.2060	M6 x 1,0	5,00	50,0	331.2307	331.3327	331.3347	19,0	40	20,50
331.2070	M7 x 1,0	6,00	50,0	331.2308	331.3328	331.3348	19,0	44	31,50
331.2080	M8 x 1,25	6,80	56,0	331.2309	331.3329	331.3349	22,0	48	31,50
331.2100	M10 x 1,5	8,50	70,0	331.2310	331.3330	331.3350	24,0	92	39,50
331.2110	M11 x 1,5	8,50	70,0	331.2311	331.3331	331.3351	24,0	112	50,50
331.2120	M12 x 1,75	10,20	75,0	331.2312	331.3332	331.3352	29,0	134	50,50
331.2140	M14 x 2,0	12,00	80,0	331.2313	331.3333	331.3353	30,0	200	65,50
331.2160	M16 x 2,0	14,00	80,0	331.2314	331.3334	331.3354	32,0	230	90,90
331.2180	M18 x 2,5	15,50	95,0	331.2315	331.3335	331.3355	40,0	365	117,90
331.2200	M20 x 2,5	17,50	95,0	331.2316	331.3336	331.3356	40,0	445	160,50
331.2220	M22 x 2,5	19,50	100,0	331.2317	331.3337	331.3357	40,0	470	192,50
331.2240	M24 x 3,0	21,00	110,0	331.2318	331.3338	331.3358	50,0	530	256,90
331.2270	M27 x 3,0	24,00	110,0	331.2319	331.3339	331.3359	50,0	565	374,50
331.2300	M30 x 3,5	26,50	125,0	331.2320	331.3340	331.3360	56,0	606	374,50

HSS tap and die set in metal case

- Universal set
- Straight forward hand thread cutting
- With adjustable tap wrench and die holder
- Includes thread gauge and screwdriver
- High performance steel



		kg	€
331.0632	32 pcs HSS tap and die set in metal case	1,32	133,90
21 x	M3 - M4 - M5 - M6 - M8 - M10 - M12		
7 x	M3 - M4 - M5 - M6 - M8 - M10 - M12		
1 x	M7 - M9		
1 x	M1 - M12		
1 x			
1 x			

HSS tap and die set in metal case

- Straight forward hand thread cutting
- With adjustable tap wrench and die holder
- Includes thread gauge and screwdriver
- High performance steel



		kg	€
331.0654	54 pcs HSS tap and die set in metal case	8,30	460,50
33 x	M3 - M4 - M5 - M6 - M8 - M10 - M12 - M14 - M15 - M18 - M20		
11 x	M3 - M4 - M5 - M6 - M8 - M10 - M12 - M14 - M15 - M18 - M20		
6 x	M3-M4 - M4,5-M6 - M7-M9 - M10-M11 - M12-M14 - M16-M20		
2 x	M1-M10 - M5-M20		
1 x			
1 x			

HSS Co hand drill tap set M in metal case

- High strength hinge
- DIN 352
- Tolerance according to ISO 2 / 6H
- Right hand cutting
- Includes second and bottom tap
- For running and blind hole threads
- With hard metal centre
- Surface without discolouration
- High performance cobalt steel
- Each size includes 1x second and bottom tap

Ideally usable in high and low alloyed steel up to 900 N/mm² stability, cast iron and NE metals.



Taper tap: ca. 5 - 6 cutting gears
Second tap: ca. 4 - 5 cutting gears
Bottom tap: ca. 2 - 3 cutting gears

		kg	€
336.0631	21 pcs M3 - M4 - M5 - M6 - M8 - M10 - M12	620	235,50

HSS Co tap and die set in metal case

- Universal set
- Straight forward hand thread cutting
- With adjustable tap wrench and die holder
- Includes thread gauge and screwdriver
- High performance cobalt steel



		kg	€
331.0732	32 pcs HSS Co tap and die set in metal case	1,32	363,90
21 x	M3 - M4 - M5 - M6 - M8 - M10 - M12		
7 x	M3 - M4 - M5 - M6 - M8 - M10 - M12		
1 x	M7 - M9		
1 x	M1 - M12		
1 x			

HSS Co tap and die set in metal case

- Universal set
- Straight forward hand thread cutting
- With adjustable tap wrench and die holder
- Includes thread gauge and screwdriver
- High performance cobalt steel



		kg	€
331.0754	54 pcs HSS Co tap and die set in metal case	8,30	1230,50
33 x	M3 - M4 - M5 - M6 - M8 - M10 - M12 M14 - M15 - M18 - M20		
11 x	M3 - M4 - M5 - M6 - M8 - M10 - M12 M14 - M15 - M18 - M20		
6 x	M3-M4 - M4,5-M6 - M7-M9 - M10 M11 - M12-M14 - M16-M20		
2 x	M1-M10 - M5-M20		
1 x			
1 x			

HSS Co hand drill tap set M in plastic case

- Stackable for storage
- With integral clasp
- High strength hinge
- DIN 352
- Tolerance according to ISO 2 / 6H
- Right hand cutting
- Includes second and bottom tap
- For running and blind hole threads
- With hard metal centre
- Surface without discolouration
- High performance cobalt steel
- Each size includes 1x second and bottom tap

Ideally usable in high and low alloyed steel up to 900 N/mm² stability, cast iron and NE metals.



Taper tap: ca. 5 - 6 cutting gears
Second tap: ca. 4 - 5 cutting gears
Bottom tap: ca. 2 - 3 cutting gears

		kg	€
336.0651	21 pcs M3 - M4 - M5 - M6 - M8 - M10 - M12	620	251,50

HSS Co tap and die set in metal case

- Universal set
- Straight forward hand thread cutting
- With adjustable tap wrench and die holder
- Includes thread gauge and screwdriver
- High performance cobalt steel



		kg	€
331.0744	44 pcs HSS Co tap and die set in metal case	3,93	524,50
21 x	M3 - M4 - M5 - M6 - M8 - M10 - M12		
7 x	2,5 - 3,3 - 4,2 - 5 - 6,8 - 8,5 - 10,2 mm		
7 x	M3 - M4 - M5 - M6 - M8 - M10 - M12		
5 x	M3-M4 - M4,5-M6 - M7-M9 - M10 M11 - M12-M14		
2 x	M1-M10 - M3-M12		
1 x			
1 x			

DIE STOCKS

HSS die M

- DIN EN 22568 form B
- Tolerance according to ISO - 6g
- Right hand cutting
- Specification, ground cutting edge
- Metric thread
- Surface without discolouration
- High performance steel

Ideally usable in high and low alloyed steel up to 800 N/mm² tensile

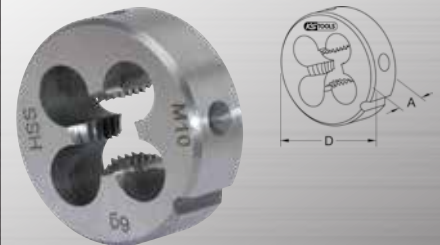

		A mm	D mm	Contact	kg	€
332.0030	M3 x 0,50	5,0	20,0	1	8	5,50
332.0040	M4 x 0,70	5,0	20,0	1	10	5,50
332.0050	M5 x 0,80	7,0	20,0	1	12	5,50
332.0060	M6 x 1,00	7,0	20,0	1	14	5,50
332.0070	M7 x 1,00	9,0	25,0	1	18	7,50
332.0080	M8 x 1,25	9,0	25,0	1	20	7,50
332.0090	M9 x 1,25	9,0	25,0	1	35	7,50
332.0100	M10 x 1,50	11,0	30,0	1	50	11,90
332.0120	M12 x 1,75	14,0	38,0	1	60	19,50
332.0140	M14 x 2,00	14,0	38,0	1	73	20,50
332.0160	M16 x 2,00	18,0	40,0	1	199	33,50
332.0180	M18 x 2,50	18,0	40,0	1	220	33,50
332.0200	M20 x 2,50	18,0	40,0	1	240	33,50

HSS die MF

- DIN EN 22568 form B
• Tolerance according to ISO - 6g
• Right hand cutting
• Specification, ground cutting edge
• Metric fine thread
• Surface without discolouration
• High performance steel

Ideally usable in high and low alloyed steel up to 800 N/mm² stability and NE metals.

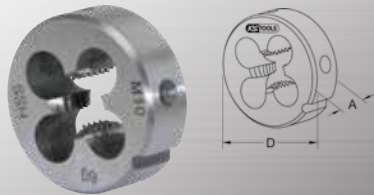

Table with 7 columns: Part number, Thread (mm), A (mm), D (mm), Content, Weight (g), and Price (€). Rows include items like 332.1000, 332.1001, up to 332.1063.

HSS Co die M

- DIN EN 22568 form B
• Tolerance according to ISO - 6g
• Right hand cutting
• Specification, ground cutting edge
• Metric thread
• Surface without discolouration
• High performance cobalt high speed steel

Ideally usable in high and low alloyed steel up to 900 N/mm² stability and NE metals.

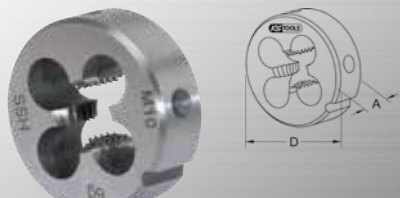

Table with 7 columns: Part number, Thread (mm), A (mm), D (mm), Content, Weight (g), and Price (€). Rows include items like 332.0001, 332.0002, up to 332.0013.

HSS hexagon die M

- DIN 382
• Tolerance according to ISO - 6g
• Right hand cutting
• Ground execution
• Metric thread
• Surface without discolouration
• High performance steel

Ideally usable in high and low alloyed steel up to 800 N/mm² stability and NE metals.

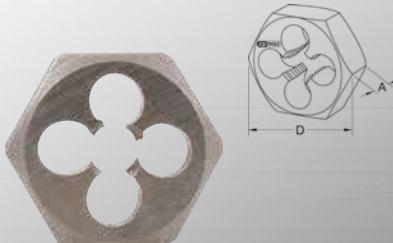

Table with 7 columns: Part number, Thread (mm), A (mm), D (mm), Content, Weight (g), and Price (€). Rows include items like 330.0030, 330.0040, up to 330.0200.

HSS hexagon die MF

- DIN 382
• Tolerance according to ISO - 6g
• Right hand cutting
• Ground execution
• Metric fine thread
• Surface without discolouration
• High performance steel

Ideally usable in high and low alloyed steel up to 800 N/mm² stability and NE metals.

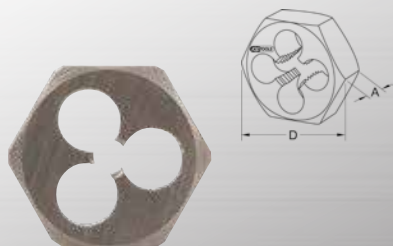

Table with 7 columns: Part number, Thread (mm), A (mm), D (mm), Content, Weight (g), and Price (€). Rows include items like 333.0017, 333.0018, up to 333.0034.

Table with 7 columns: Part number, Thread (mm), A (mm), D (mm), Content, Weight (g), and Price (€). Rows include items like 333.0035, 333.0036, up to 333.0058.

TAP WRENCHES AND DIE HOLDERS

Adjustable tap wrench

- DIN 1814
• With two jaw collet chuck
• With steel rail
• Hardened clamping jaws
• Ideal to the thread cutting edge
• To that separating from thin sheet metals
• For difficult to access areas
• Die cast zinc housing

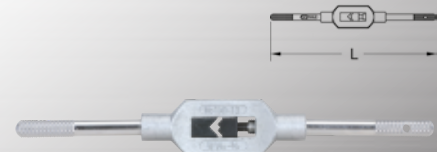

Table with 6 columns: Part number, Thread range, L (mm), Content, Weight (g), and Price (€). Rows include items like 331.0011, 331.0029, up to 331.0019.

Ball tap holder

- For fast interchanging of the taps
• Square shaft according to DIN 10
• Die cast zinc housing



Table with 6 columns: Part number, Thread range, L (mm), Content, Weight (g), and Price (€). Rows include items like 331.0253, 331.0254, up to 331.0259.

Die holder with exact gearing reversible ratchet head

- Clockwise and anticlockwise action with positive adjustment
- With two jaw collet chuck
- With movable drive handle
- Ideal to the thread cutting edge
- For difficult to access areas
- Mirror polished
- Special tool steel

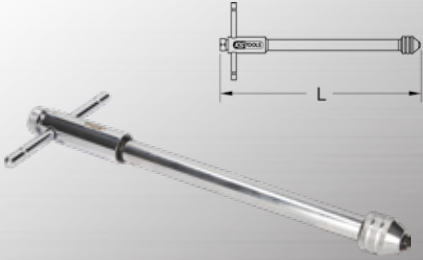

		L mm	Content	kg	€
331.0660	M3 - M10	85,0	1	190	10,90
331.0665	M5 - M12	110,0	1	320	13,90
331.0670	M3 - M10	250,0	1	250	18,50
331.0675	M5 - M12	320,0	1	440	21,50

Thread drilling extension

- DIN 377
- Hardened and ground execution
- Square shaft according to DIN 10
- For the extension of the hand threading tap
- High performance steel



		D mm	L mm	Content	kg	€
331.0241	M1 - M2,6	2,1	2,5 60,0	1 10	3,50	
331.0242	M3	2,7	3,7 80,0	1 15	4,50	
331.0243	M4	3,4	4,5 95,0	1 40	4,50	
331.0244	M5 - M8	4,9	6,5 110,0	1 44	5,50	
331.0245	M9 - M10	5,5	7,0 115,0	1 55	6,50	
331.0246	M12	7,0	9,0 125,0	1 120	7,50	
331.0247	M13 - M16	9,0	12,0 135,0	1 135	8,50	
331.0248	M18	11,0	14,0 150,0	1 150	10,90	
331.0249	M20	12,0	16,0 155,0	1 175	11,90	

Die holder

- DIN 225
- Reinforcement of the cutting edge through iron screws
- With steel rail
- Die cast zinc housing



		L mm	Content	kg	€
331.0001	M1 - M2,6	160,0	1	60	3,50
331.0002	M3 - M4	200,0	1	60	5,50
331.0003	M5 - M6	200,0	1	70	5,50
331.0004	M7 - M9	224,0	1	100	6,50
331.0005	M10 - M11	280,0	1	220	8,50
331.0006	M12 - M14	315,0	1	280	12,90
331.0007	MF12 - MF14	315,0	1	260	12,90
331.0008	M16 - M20	450,0	1	480	18,50
331.0009	MF16 - MF21	450,0	1	460	18,50
331.0022	MF22 - MF24	560,0	1	860	22,50
331.0023	M22 - M24	560,0	1	840	23,50
331.0024	MF27 - MF36	560,0	1	1230	43,90
331.0026	M27 - M36	560,0	1	1190	43,90

Threading die adaptor set

- Universal use for round cutting dies according to DIN E 22568 form B
- Slim design
- Ideal for difficult to access areas
- Internal square drive to DIN 3120 / ISO 1174 with ball reception
- Includes extension and locking knob
- Special tool steel
- In durable plastic storage case



		kg	€
331.0620	8 pcs Threading die adaptor set	1,94	213,90

consists of:

		kg
331.0621	Die adaptor, M3-M6, 24mm	60
331.0622	Die adaptor, M7-M8, 24mm	50
331.0623	Die adaptor, M9-M10, 24mm	90
331.0624	Die adaptor, M11-M14, 41mm	230
331.0625	Die adaptor, M18-M20, 41mm	360
331.0626	Die adaptor, M22-M24, 41mm	430
331.0627	Toggle f.extension f.die adaptor	120
331.0628	1/2" extension f.die adaptor	250

THREAD GAUGES

Thread gauge

- For controlling and increasing the interior thread and outside thread
- Imperial sizes
- Cylindrical tapered
- Leaves fan shaped arrangement
- Leaves individually marked with size
- Out of hardened spring steel

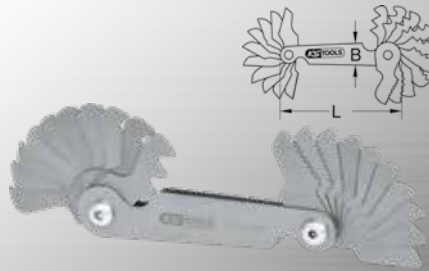

	Tooth pitch for thread size	B mm	L mm	kg	€
301.0090	4-4,5-5-6-7-8-9-10-11-12-13-14-16-18 20-22-24-32-40-48-56-64 speed	12,2	66,5	40	6,50
301.0095	0,40-0,45-0,50-0,60-0,70-0,75-0,80-1,00-1,25-1,50-1,75-2,00-2,50-3,00-3,50-4,00-4,50-5,00-5,50-6,00mm	12,2	66,5	40	6,50

ROTARY BURRS

Round cone rotary burr form L for aluminium alloys, long

- Minimal material adhesion
- Long life time
- Big removal rates and high cutting performance
- For cutting speed up to max 1100 m/min (max. speed 16.000 - 30.000 rpm)
- Smooth running

To that filleted, edges break, plasters, welded seams and area preparation

Suitable for Aluminum alloys, hard Aluminum alloys (high SI portion), brass, copper, zinc, bronze, titanium, fiber-reinforced plastics GFK/CFK, thermoplastics, hard rubber

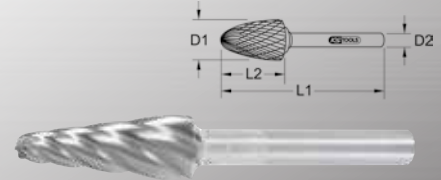

	D1 mm	D2 mm	L1 mm	L2 mm	Content	kg	€
515.3291	12,0	6,0	65,0	25,0	1	35	54,50

Round milling rotary burr form C for aluminium alloys

- Minimal material adhesion
- Long life time
- Big removal rates and high cutting performance
- For cutting speed up to max 1100 m/min (max. speed 16.000 - 30.000 rpm)
- Smooth running

To that filleted, edges break, plasters, welded seams and area preparation

Suitable for Aluminum alloys, hard Aluminum alloys (high SI portion), brass, copper, zinc, bronze, titanium, fiber-reinforced plastics GFK/CFK, thermoplastics, hard rubber

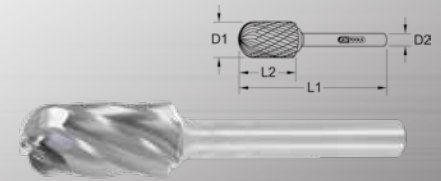

	D1 mm	D2 mm	L1 mm	L2 mm	Content	kg	€
515.3292	12,0	6,0	65,0	25,0	1	45	48,50

Cylinder rotary burr form A with spur gearing for aluminium alloys

- Minimal material adhesion
- Long life time
- Big removal rates and high cutting performance
- For cutting speed up to max 1100 m/min (max. speed 16.000 - 30.000 rpm)
- Smooth running

To that filleted, edges break, plasters, welded seams and area preparation

Suitable for Aluminum alloys, hard Aluminum alloys (high SI portion), brass, copper, zinc, bronze, titanium, fiber-reinforced plastics GFK/CFK, thermoplastics, hard rubber

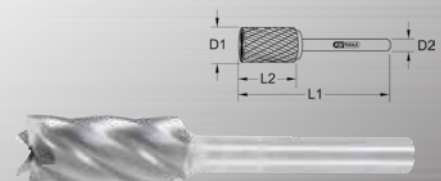

	D1 mm	D2 mm	L1 mm	L2 mm	Content	kg	€
515.3293	12,0	6,0	65,0	25,0	1	46	47,50

Round milling rotary burr form D for aluminium alloys

- Minimal material adhesion
- Long life time
- Big removal rates and high cutting performance
- For cutting speed up to max 1100 m/min (max. speed 16.000 - 30.000 rpm)
- Smooth running

To that filleted, edges break, plasters, welded seams and area preparation

Suitable for Aluminum alloys, hard Aluminum alloys (high SI portion), brass, copper, zinc, bronze, titanium, fiber-reinforced plastics GFK/CFK, thermoplastics, hard rubber

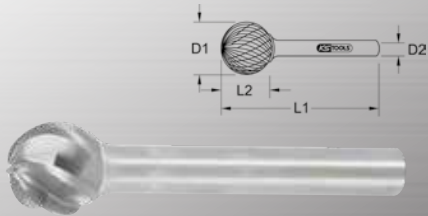

	D1 mm	D2 mm	L1 mm	L2 mm	Content	g	€
515.3294	12,0	6,0	50,0	10,0	1	27	31,50

Round cone rotary burr form L for aluminium alloys, short

- Minimal material adhesion
- Long life time
- Big removal rates and high cutting performance
- For cutting speed up to max 1100 m/min (max. speed 16.000 - 30.000 rpm)
- Smooth running

To that filleted, edges break, plasters, welded seams and area preparation

Suitable for Aluminum alloys, hard Aluminum alloys (high SI portion), brass, copper, zinc, bronze, titanium, fiber-reinforced plastics GFK/CFK, thermoplastics, hard rubber

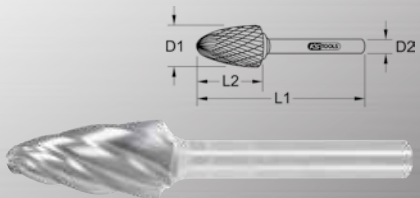

	D1 mm	D2 mm	L1 mm	L2 mm	Content	g	€
515.3295	12,0	6,0	65,0	25,0	1	37	43,90

Cylinder rotary burr form A without spur gearing

- Minimal material adhesion
- Long life time
- Big removal rates and high cutting performance
- For cutting speed up to max 1100 m/min (max. speed 16.000 - 30.000 rpm)
- Smooth running

To that filleted, edges break, plasters, welded seams and area preparation

Suitable for Aluminum alloys, hard Aluminum alloys (high SI portion), brass, copper, zinc, bronze, titanium, fiber-reinforced plastics GFK/CFK, thermoplastics, hard rubber

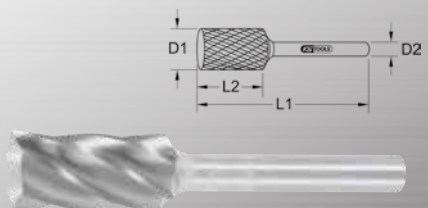

	D1 mm	D2 mm	L1 mm	L2 mm	Content	g	€
515.3296	12,0	6,0	65,0	25,0	1	47	42,90

Milling burr set for aluminum alloys in plastic case

- Minimal material adhesion
- Long life time
- Big removal rates and high cutting performance
- For cutting speed up to max 1100 m/min (max. speed 16.000 - 30.000 rpm)
- Smooth running

To that filleted, edges break, plasters, welded seams and area preparation

Suitable for Aluminum alloys, hard Aluminum alloys (high SI portion), brass, copper, zinc, bronze, titanium, fiber-reinforced plastics GFK/CFK, thermoplastics, hard rubber



	Content	g	€
515.3290	3 pcs	Milling burr set for aluminum alloys in plastic case	101 160,50
1 x		12 mm	
1 x		12 mm	
1 x		12 mm	

Hard metal cylinder rotary burr form A without spur gearing

- Highest cutting edge stability
- Improved cutting performance due to staggered tooth system
- Without spur gearing
- Surface without discolouration
- High performances steel with hard metal

To that filleted, edges break, plasters, welded seams and area preparation.
Usably in high alloyed, steel rustproof, acid and heat resistant, cast and plastics.



	D1 mm	D2 mm	L1 mm	L2 mm	Content	g	€
515.3221	3,0	3,0	38,5	13,0	1	3	6,50
515.3222	6,0	6,0	61,0	16,0	1	16	10,90
515.3223	8,0	6,0	65,0	20,0	1	21	13,90
515.3224	10,0	6,0	65,0	20,0	1	30	21,50
515.3225	12,0	6,0	70,0	25,0	1	57	31,50
515.3226	16,0	6,0	70,0	25,0	1	81	50,50

Hard metal cylinder rotary burr form A with spur gearing

- Highest cutting edge stability
- Improved cutting performance due to staggered tooth system
- With face gearing
- Suitable for a wide range of applications
- Surface without discolouration
- High performances steel with hard metal

To that filleted, edges break, plasters, welded seams and area preparation.
Usably in high alloyed, steel rustproof, acid and heat resistant, cast and plastics.

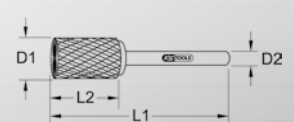

	D1 mm	D2 mm	L1 mm	L2 mm	Content	g	€
515.3231	3,0	3,0	38,5	13,0	1	3	6,50
515.3232	6,0	6,0	61,0	16,0	1	16	14,90
515.3233	8,0	6,0	65,0	20,0	1	21	14,90
515.3234	10,0	6,0	65,0	20,0	1	30	22,50
515.3235	12,0	6,0	70,0	25,0	1	57	25,90
515.3236	16,0	6,0	70,0	25,0	1	81	47,50

Hard metal round milling rotary burr form C

- Highest cutting edge stability
- Improved cutting performance due to staggered tooth system
- Suitable for a wide range of applications
- Surface without discolouration
- High performances steel with hard metal

To that filleted, edges break, plasters, welded seams and area preparation.
Usably in high alloyed, steel rustproof, acid and heat resistant, cast and plastics.



	D1 mm	D2 mm	L1 mm	L2 mm	Content	g	€
515.3241	3,0	3,0	38,5	13,0	1	3	6,50
515.3242	6,0	6,0	61,0	16,0	1	16	13,90
515.3243	8,0	6,0	65,0	20,0	1	22	18,50
515.3244	10,0	6,0	70,0	20,0	1	28	16,50
515.3245	12,0	6,0	70,0	25,0	1	40	23,50
515.3246	16,0	6,0	70,0	25,0	1	60	53,50

Hard metal pointed arch rotary burr form G

- Highest cutting edge stability
- Improved cutting performance due to staggered tooth system
- Suitable for a wide range of applications
- Surface without discolouration
- High performances steel with hard metal

To that filleted, edges break, plasters, welded seams and area preparation.
 Usably in high alloyed, steel rustproof, acid and heat resistant, cast and plastics.

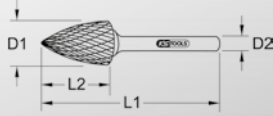

	D1 mm	D2 mm	L1 mm	L2 mm	Content	g	€
515.3251	3,0	3,0	38,5	13,0	1	3	6,50
515.3252	6,0	6,0	63,0	18,0	1	13	12,90
515.3253	8,0	6,0	65,0	20,0	1	19	13,90
515.3254	10,0	6,0	65,0	20,0	1	22	19,50
515.3255	12,0	6,0	70,0	25,0	1	33	24,90
515.3256	16,0	6,0	70,0	25,0	1	47	43,90

Hard metal tip cone milling burr form M

- Highest cutting edge stability
- Improved cutting performance due to staggered tooth system
- Suitable for a wide range of applications
- Surface without discolouration
- High performances steel with hard metal

To that filleted, edges break, plasters, welded seams and area preparation.
 Usably in high alloyed, steel rustproof, acid and heat resistant, cast and plastics.

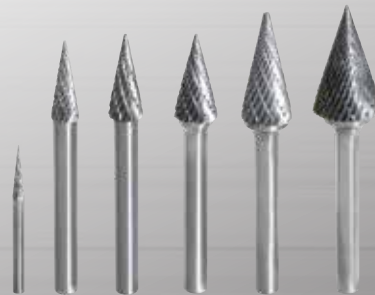

	D1 mm	D2 mm	L1 mm	L2 mm	Content	g	€
515.3271	3,0	3,0	38,5	11,0	1	3	6,50
515.3272	6,0	6,0	63,0	18,0	1	12	11,90
515.3273	8,0	6,0	65,0	20,0	1	15	14,90
515.3274	10,0	6,0	65,0	20,0	1	18	18,50
515.3275	12,0	6,0	70,0	25,0	1	26	24,90
515.3276	16,0	6,0	70,0	25,0	1	37	39,50

Hard metal milling burr set in steel case

- High strength hinge
- 6 mm shank diameter
- Highest cutting edge stability
- Improved cutting performance due to staggered tooth system
- Surface without discolouration
- High performances steel with hard metal

To that filleted, edges break, plasters, welded seams and area preparation.
 Usably in high alloyed, steel rustproof, acid and heat resistant, cast and plastics.



			g	€
515.3203	3 pcs	Hard metal milling burr set in steel case	590	60,90
1 x		10 mm		
1 x		10 mm		
1 x		10 mm		

Hard metal round arch rotary burr form F

- Highest cutting edge stability
- Improved cutting performance due to staggered tooth system
- Suitable for a wide range of applications
- Surface without discolouration
- High performances steel with hard metal

To that filleted, edges break, plasters, welded seams and area preparation.
 Usably in high alloyed, steel rustproof, acid and heat resistant, cast and plastics.

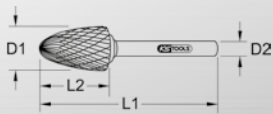

	D1 mm	D2 mm	L1 mm	L2 mm	Content	g	€
515.3261	3,0	3,0	38,5	13,0	1	3	6,50
515.3262	6,0	6,0	61,0	16,0	1	15	12,90
515.3263	8,0	6,0	65,0	20,0	1	20	16,50
515.3264	10,0	6,0	65,0	20,0	1	24	19,50
515.3265	12,0	6,0	70,0	25,0	1	32	24,90
515.3266	16,0	6,0	70,0	25,0	1	52	43,90

Hard metal ball milling burr form D

- Highest cutting edge stability
- Improved cutting performance due to staggered tooth system
- Suitable for a wide range of applications
- Surface without discolouration
- High performances steel with hard metal

To that filleted, edges break, plasters, welded seams and area preparation.
 Usably in high alloyed, steel rustproof, acid and heat resistant, cast and plastics.



	D1 mm	D2 mm	L1 mm	L2 mm	Content	g	€
515.3281	3,0	3,0	38,5	2,7	1	3	6,50
515.3282	6,0	6,0	51,0	5,0	1	11	8,50
515.3283	8,0	6,0	53,0	7,0	1	12	14,90
515.3284	10,0	6,0	54,0	9,0	1	16	13,90
515.3285	12,0	6,0	56,0	10,0	1	24	18,50
515.3286	16,0	6,0	60,0	14,0	1	59	32,50

Hard metal milling burr set in steel case

- High strength hinge
- 3 mm shank diameter
- Highest cutting edge stability
- Improved cutting performance due to staggered tooth system
- Surface without discolouration
- High performances steel with hard metal

To that filleted, edges break, plasters, welded seams and area preparation.
 Usably in high alloyed, steel rustproof, acid and heat resistant, cast and plastics.

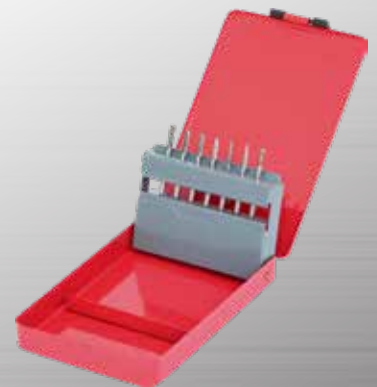

			g	€
515.3207	7 pcs	Hard metal milling burr set in steel case	590	43,90
1 x		3 mm		
1 x		3 mm		
1 x		3 mm		
1 x		3 mm		
1 x		3 mm		
1 x		3 mm		

HSS Bi metal holesaws

- Variable tooth pitch
- Right hand cutting
- High concentricity accuracy
- Good chip removal
- HSS Bi metal
- Cutting depth up to max. 38 mm

Suitable for low alloyed steel up to 700 N/mm² stability, plaster, light construction-, fibre and chipboard as well as wood processing, non ferrous metals and light alloys.

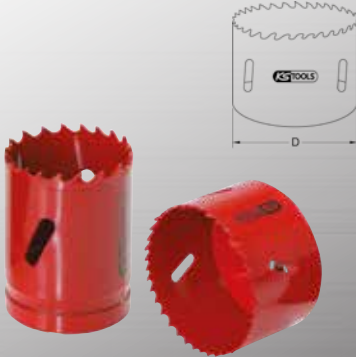

	D mm	Cutting depth mm	Passage Ø	Imperial tube Ø inch	Content	kg	€
129.5014	14,0	38,0		9/16"	1	30	5,50
129.5016	16,0	38,0	PG9	5/8"	1	30	4,50
129.5017	17,0	38,0		11/16"	1	30	4,50
129.5019	19,0	38,0	PG11	3/4"	1	40	4,50
129.5020	20,0	38,0		25/32"	1	40	5,50
129.5021	21,0	38,0	PG13,5	13/16"	1	50	5,50
129.5022	22,0	38,0		7/8"	1	50	5,50
129.5024	24,0	38,0	PG16	15/16"	1	60	6,50
129.5025	25,0	38,0		1"	1	60	6,50
129.5027	27,0	36,0		1.1/16"	1	70	8,50
129.5029	29,0	36,0	PG21	1.1/8"	1	70	7,50
129.5030	30,0	36,0		1.3/16"	1	80	7,50
129.5032	32,0	36,0		1.1/4"	1	80	10,90
129.5033	33,0	36,0		1.5/16"	1	80	7,50
129.5035	35,0	36,0		1.3/8"	1	90	8,50
129.5037	37,0	36,0	PG29	1.7/16"	1	120	8,50
129.5038	38,0	36,0		1.1/2"	1	120	8,50
129.5040	40,0	36,0		1.9/16"	1	120	10,90
129.5041	41,0	36,0		1.5/8"	1	120	8,50
129.5043	43,0	36,0		1.11/16"	1	120	8,50
129.5044	44,0	36,0		1.3/4"	1	120	9,90
129.5045	45,0	36,0		1.25/32"	1	135	9,90
129.5046	46,0	36,0		1.13/16"	1	140	9,90
129.5048	48,0	36,0	PG36	1.7/8"	1	150	9,90
129.5050	50,0	32,0		1.31/32"	1	150	10,90
129.5051	51,0	32,0		2"	1	150	10,90
129.5052	52,0	32,0		2.1/16"	1	150	10,90
129.5054	54,0	32,0	PG42	2.1/8"	1	150	10,90
129.5055	55,0	32,0	PG9	2.3/16"	1	150	11,90
129.5057	57,0	32,0		2.1/4"	1	160	11,90
129.5059	59,0	32,0		2.5/16"	1	160	11,90
129.5060	60,0	32,0	PG48	2.3/8"	1	170	11,90
129.5064	64,0	32,0		2.1/2"	1	190	12,90
129.5065	65,0	32,0		2.9/16"	1	200	12,90
129.5067	67,0	32,0		2.5/8"	1	200	13,90
129.5068	68,0	32,0		2.22/32"	1	200	13,90
129.5070	70,0	32,0		2.3/4"	1	210	13,90
129.5073	73,0	32,0		2.7/8"	1	250	14,90
129.5075	75,0	32,0		2.31/32"	1	250	14,90
129.5076	76,0	32,0		3"	1	250	14,90
129.5079	79,0	32,0		3.1/8"	1	250	16,50
129.5083	83,0	32,0		3.1/4"	1	260	17,50
129.5086	86,0	32,0		3.3/8"	1	260	17,50
129.5089	89,0	32,0		3.1/2"	1	290	18,50
129.5092	92,0	32,0		3.5/8"	1	320	18,50
129.5095	95,0	32,0		3.3/4"	1	370	19,50
129.5098	98,0	32,0		3.7/8"	1	390	19,50
129.5100	100,0	32,0		3.31/32"	1	410	20,50
129.5102	102,0	32,0		4"	1	420	20,50
129.5105	105,0	32,0		4.1/8"	1	450	21,50
129.5108	108,0	32,0		4.1/4"	1	450	21,50
129.5111	111,0	32,0		4.3/8"	1	460	22,50
129.5114	114,0	32,0		4.1/2"	1	480	23,50
129.5121	121,0	32,0		4.3/4"	1	500	24,90
129.5127	127,0	32,0		5"	1	650	26,90
129.5140	140,0	32,0		5.1/2"	1	650	27,90
129.5146	146,0	32,0		5.3/4"	1	650	28,90
129.5152	152,0	32,0		6"	1	700	29,90

Electricians hole saw set in plastic box

- Includes hole saw arbor
- With integral clasp
- High strength hinge
- Variable tooth pitch
- Right hand cutting
- High concentricity accuracy
- Good chip removal
- HSS Bi metal

Suitable for high and low alloyed steel up to 700 N/mm² stability, plaster, light construction, MDF and chipboard as well as wood processing, non ferrous metal and light alloy. For use within electrical trades.



	kg	€		
129.5570	8 pcs	Electricians hole saw set in plastic box	1,35	72,90
6 x		22 - 29 - 35 - 44 - 51 - 68 mm		
1 x		14 - 30 mm		
1 x		32 - 152 mm		

Plumbing hole saw set in plastic box

- Includes hole saw arbor
- With integral clasp
- High strength hinge
- Variable tooth pitch
- Right hand cutting
- High concentricity accuracy
- Good chip removal
- HSS Bi metal

Suitable for high and low alloyed steel up to 700 N/mm² stability, plaster, light construction, MDF and chipboard as well as wood processing, non ferrous metal and light alloy. For use within plumbing trades.



	kg	€		
129.5575	9 pcs	Plumbing hole saw set in plastic box	1,38	74,90
7 x		19 - 22 - 29 - 38 - 44 - 51 - 57 mm		
1 x		14 - 30 mm		
1 x		32 - 152 mm		

Universal hole saw set in plastic box

- Inclusive hole saw arbor and extension
- With integral clasp
- High strength hinge
- Variable tooth pitch
- Right hand cutting
- High concentricity accuracy
- Good chip removal
- HSS Bi metal

Suitable for high and low alloyed steel up to 700 N/mm² stability, plaster, light construction, MDF and chipboard as well as wood processing, non ferrous metal and light alloy. For the use in the areas electric, sanitary, plumbing building and heating.



	kg	€		
129.5580	15 pcs	Universal hole saw set in plastic box	3,49	117,90
12 x		19 - 22 - 25 - 29 - 32 - 35 - 38 - 44 - 51 - 57 - 64 - 68 mm		
1 x		14 - 30 mm		
1 x		32 - 152 mm		
1 x		300 mm		

HANDSAWS

Wire saw

- Ideally suited for cutting ABS, PVC, CPVC pipes and wood
- For hard-to-reach places and corners
- With metal rings at both ends for a firm grip
- Easy to stow
- Very flexible
- Braided wire



	Length mm	kg	€
123.0005	650,0	35	7,50

Small handsaw

- With 32 teeth
- For metal
- With wooden handle
- Includes saw blade



	L mm	H mm	kg	€	
997.1215	150,0	130,0	997.1214/16	100	10,90

Small handsaw with adjustable wooden handle

- With 32 teeth
- For metal
- With adjustable wooden handle
- Includes saw blade

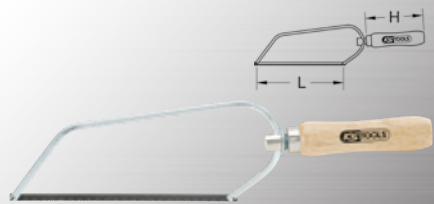

	L mm	H mm			€
997.1217	150.0	90.0	997.1214/16	100	17,50

Sawblade

- With 32 teeth
- Suitable for: all metals



	L mm	Content		€
997.1214	150,0	12	36	11,90

Sawblade

- With 25 teeth
- Suitable for: wood, aluminium, plastics and plaster

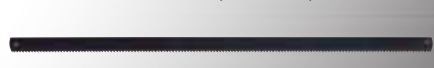

	L mm	Content		€
997.1216	150,0	12	40	11,90

Small handsaw frame

- With 24 teeth
- With red plastic handle cover
- Includes universal saw blade
- For wood, metal, aluminum, plastic and plaster
- Surface black powder coating

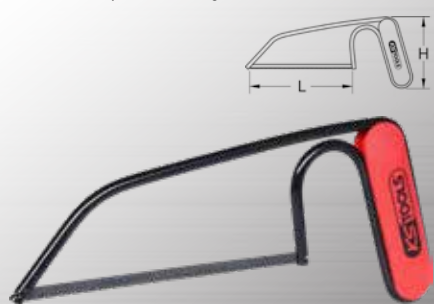

	L mm	H mm			€
997.1210	150.0	90.0	907.2131	130	9,90

Small hand saw frame

- With 24 teeth
- With black plastic handle cover
- Includes universal saw blade
- For plastic, metal and aluminium

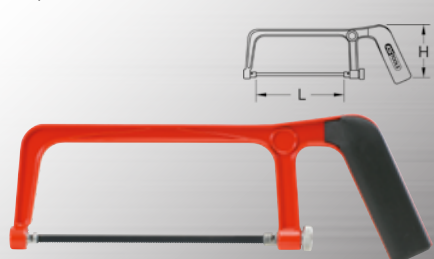

	L mm	H mm			€
907.2130	150.0	90.0	907.2131	140	7,50

Universal sawblade for small handsaw frame

- With 24 teeth
- For: plastic, metal and aluminium

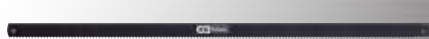

	L mm	Content		€
907.2131	150,0	1	10	1,50

Metal handsaw frame

- Suitable for narrow spaces
- Mode of operation such as key hole sawing
- Two component handle
- Includes universal saw blade
- For plastic, metal and aluminium



	L mm	H mm			€
907.2125	300.0	160.0	129.6620-24	110	11,90

Hack saw frame

- Easy usage
- With hand protection and thumb support
- Includes magazine for saw blades
- Includes jigsaw function
- Saw blade can be set at 45° or 90°
- Includes Bi metal sawblade

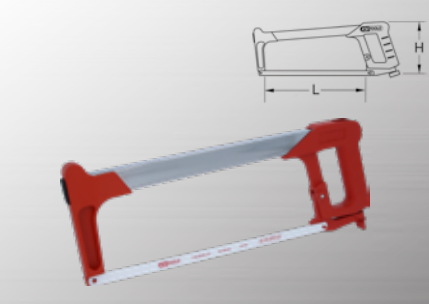

	H mm			€	
907.2100	45 or 90	130.0	129.6620-24	270	24,90

Hack saw frame

- Easy usage
- With hand protection and thumb support
- Includes magazine for saw blades
- Includes jigsaw function
- Saw blade can be set at 45° or 90°
- Two component handle
- Includes Bi metal sawblade

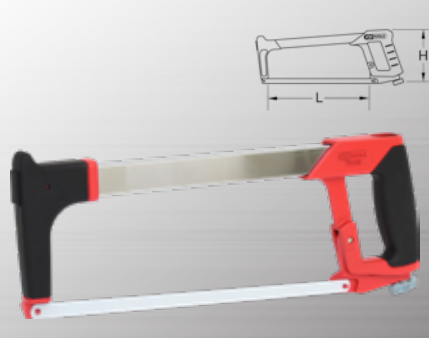

	L mm	H mm			€
907.2102	300.0	130.0	129.6620-24	270	27,90

Quick release hacksaw frame

- With fast blade clamping device
- Easy usage
- With hand protection and thumb support
- Includes magazine for saw blades
- Includes jigsaw function
- Saw blade can be set at 45° or 90°
- With ergonomic handle
- Includes Bi metal sawblade



	L mm	H mm			€
907.2110	300.0	135.0	129.6620-24	750	34,50



Hack saw frame

- With hand protection
- Includes jigsaw function
- With ergonomic handle
- Includes saw blade



	L mm	H mm			€
907.2115	300.0	130.0	129.6620-24	270	27,90

Hack saw frame set

- Including safety universal blade
- With hand protection
- Includes jigsaw function
- With ergonomic handle
- Includes saw blade



		€
907.2103	3 pcs Hack saw frame set	1,03 47,50

PVC handsaw

- With hand protection
- With ergonomic handle
- Includes saw blade



	L mm	H mm	g	€
907.1105	300.0	130.0	200	23,50
907.1106	450.0	190.0	360	24,90

HSS Bi Co 8 metal high performance saw blades

- Variable tooth pitch
- Very flexible
- For cutting metal and steel
- Cobalt alloyed HSS Bi metal

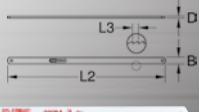

	No. teeth	B mm	D mm	L2 mm	L3 mm	Content	g	€
129.6620V	288	13,0	0,6	300,0	1,0-1,3	1	20	2,50

HSS Bi Co 8 metal high performance saw blades

- Very flexible
- For cutting metal and steel
- Cobalt alloyed HSS Bi metal

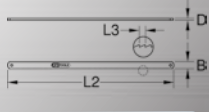

	No. teeth	B mm	D mm	L2 mm	L3 mm	Content	g	€
129.6620-18	216	13,0	0,6	300,0	1,4	1	20	2,50
129.6620-24	288	13,0	0,6	300,0	1,0	1	20	2,50
129.6620-32	384	13,0	0,6	300,0	0,8	1	20	2,50

JIGSAW BLADES

Jigsaw blades

- Cleaner, fast and fine cut
- Chrome vanadium

In the style of: AEG® 274351, Bosch® T101D, Metabo® 23635, Lenox® CF456S, Milwaukee® 48-42-5500
 Suitable for: Bosch®, AEG® (Atlas Copco), Metabo®, Lenox®, Milwaukee®, Elu®, Hitachi®, Holz-Her®, Mafell®, Makita®, Flex®, Sparky®

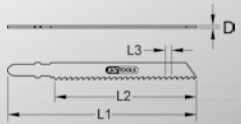

Technical data:

Suitable for: planned, hard and plywood 5 to 30 mm
 laminated wood composition board
 plastic

	No. teeth	L1 mm	L2 mm	L3 mm	D mm	Content	g	€
129.3101	30	100,0	75,0	2,5	1,5	5	40	8,50

Jigsaw blades

- Cleaner, fast and fine cut
- Chrome vanadium

In the style of: AEG® 274351, Bosch® T101D, Metabo® 23635, Lenox® CF456S, Milwaukee® 48-42-5500
 Suitable for: Bosch®, AEG® (Atlas Copco), Metabo®, Lenox®, Milwaukee®, Elu®, Hitachi®, Holz-Her®, Mafell®, Makita®, Flex®, Sparky®

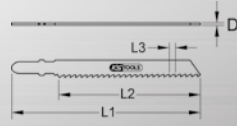

Technical data:

Suitable for: planned, hard and plywood 8 to 60 mm
 plastic
 wooden types

	No. teeth	L1 mm	L2 mm	L3 mm	D mm	Content	g	€
129.3103	18	100,0	75,0	4,0	1,5	5	30	8,50

Jigsaw blades

- Very clean and fast cut
- Chrome vanadium

In the style of: Bosch® T301D, Metabo® 23654
 Suitable for: Bosch®, AEG® (Atlas Copco), Metabo®, Lenox®, Milwaukee®, Elu®, Hitachi®, Holz-Her®, Mafell®, Makita®, Flex®, Sparky®

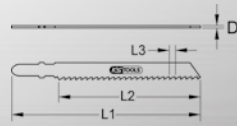

Technical data:

Suitable for: soft and hardwood 8 to 75 mm
 wood fibre board 8 to 75 mm
 plastic

	No. teeth	L1 mm	L2 mm	L3 mm	D mm	Content	g	€
129.3103S	21	115,0	95,0	4,0	1,5	5	30	9,90

Jig saw blades

- Clean and fast cut
- Extra strong blade
- Ideal for angled and parallel cutting

In the style of: Bosch® T101DP, Metabo® 23655
 Suitable for: Bosch®, AEG® (Atlas Copco), Metabo®, Lenox®, Milwaukee®, Elu®, Hitachi®, Holz-Her®, Mafell®, Makita®, Flex®, Sparky®

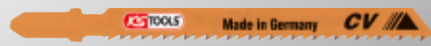
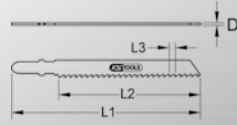

Technical data:

Suitable for: soft, hard and plywood
 wooden composites
 wood fibre board 6 to 60 mm

	No. teeth	L1 mm	L2 mm	L3 mm	D mm	Content	g	€
129.3103S	18	100,0	75,0	4,0	1,7	5	30	9,90

Jigsaw blades

- Faster, straight and clean cut
- Chrome vanadium

In the style of: AEG® 213116, Bosch® T144D, Metabo® 23633, Milwaukee® 48-42-5421
 Suitable for: Bosch®, AEG® (Atlas Copco), Metabo®, Lenox®, Milwaukee®, Elu®, Hitachi®, Holz-Her®, Mafell®, Makita®, Flex®, Sparky®

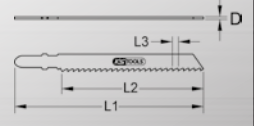

Technical data:

Suitable for: planned, hard and plywood 8 to 60 mm
 MDF

	No. teeth	L1 mm	L2 mm	L3 mm	D mm	Content	g	€
129.3104	18	100,0	75,0	4,0	1,3	5	40	6,50

Jigsaw blades curved cut

- Fast and clean cut
- Ideal for curved cutting
- Chrome vanadium

In the style of: Bosch® T244D, Metabo® 23649, Milwaukee® 48-42-5512

Suitable for: Bosch®, AEG® (Atlas Copco), Metabo®, Lenox®, Milwaukee®, Elu®, Hitachi®, Holz-Her®, Mafell®, Makita®, Flex®, Sparky®

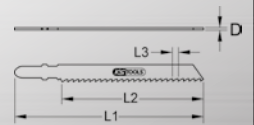

Technical data:

Suitable for: soft and hardwood 8 to 60 mm
 MDF

	No. teeth	L1 mm	L2 mm	L3 mm	D mm	Content	g	€
129.3105	18	100,0	75,0	4,0	1,3	5	30	7,50

Jigsaw blade

- Fast coarse cut
- Chrome vanadium

In the style of: AEG 254071, Bosch T111C, Metabo 23632, Milwaukee 48-42-5200
 Suitable for: Bosch®, AEG® (Atlas Copco), Metabo®, Lenox®, Milwaukee®, Elu®, Hitachi®, Holz-Her®, Mafell®, Makita®, Flex®, Sparky®

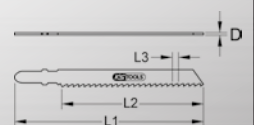

Technical data:

Suitable for: soft and hardwood 5 to 60 mm
 plastic

	No. teeth	L1 mm	L2 mm	L3 mm	D mm	Content	g	€
129.3106	24	100,0	75,0	3,0	1,3	5	30	6,50

Bi metal jigsaw blades

- Variable tooth pitch
- Straight cut
- Extra long blade
- For different strength materials

Suitable for: Bosch®, AEG® (Atlas Copco), Metabo®, Lenox®, Milwaukee®, Elu®, Hitachi®, Holz-Her®, Mafell®, Makita®, Flex®, Sparky®

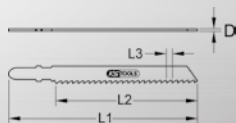

Technical data:

Suitable for: soft and hardwood 3 to 95 mm
wood with nails and kitchen worktops
steel and stainless steel

No. teeth	L1 mm	L2 mm	L3 mm	D mm	Content	€		
129.3150F	63	132,0	110,0	1,8 - 2,5	1,3	5	50	17,50

Bi metal jigsaw blades

- For thin material
- Straight cut
- Flexible and shatter proof
- Long service life

In the style of: Bosch® T118AF, Metabo® 23971, Lenox® 324S, Milwaukee® 48-42-5161

Suitable for: Bosch®, AEG® (Atlas Copco), Metabo®, Lenox®, Milwaukee®, Elu®, Hitachi®, Holz-Her®, Mafell®, Makita®, Flex®, Sparky®

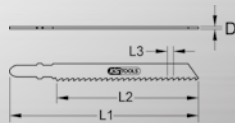

Technical data:

Suitable for: mild steel and aluminum
non ferrous metal and steel 1,5 to 3 mm
stainless steel

No. teeth	L1 mm	L2 mm	L3 mm	D mm	Content	€		
129.3111F	42	75,0	50,0	1,2	1,0	5	40	9,90

Jigsaw blades

- Clean cut
- Ideal for perspex
- High performance steel

In the style of: AEG® 274651, Bosch® T101A, Metabo® 23640
Suitable for: Bosch®, AEG® (Atlas Copco), Metabo®, Lenox®, Milwaukee®, Elu®, Hitachi®, Holz-Her®, Mafell®, Makita®, Flex®, Sparky®

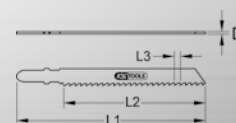

Technical data:

Suitable for: non ferrous metal and aluminium 2 to 20 mm
stainless steel 2 to 10 mm

No. teeth	L1 mm	L2 mm	L3 mm	D mm	Content	€		
129.3116	36	100,0	75,0	2,0	1,27	5	40	14,90

Jigsaw blade

- Straight cut
- Ideal for very thin material
- High performance steel

In the style of: AEG® 274652, Bosch® T118G, Metabo® 23636

Suitable for: Bosch®, AEG® (Atlas Copco), Metabo®, Lenox®, Milwaukee®, Elu®, Hitachi®, Holz-Her®, Mafell®, Makita®, Flex®, Sparky®

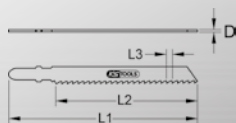

Technical data:

Suitable for: wood and aluminium 0.9 to 1.2 mm
thin sheet metals
non ferrous metal

No. teeth	L1 mm	L2 mm	L3 mm	D mm	Content	€		
129.3110	56	75,0	50,0	0,9	1,0	5	40	8,50

Bi metal jigsaw blades

- Straight cut
- For thick material

In the style of: AEG® 254064, Bosch® T118B, Metabo® 23638, Milwaukee® 48-42-5101

Suitable for: Bosch®, AEG® (Atlas Copco), Metabo®, Lenox®, Milwaukee®, Elu®, Hitachi®, Holz-Her®, Mafell®, Makita®, Flex®, Sparky®

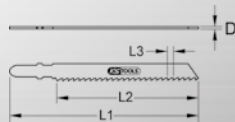

Technical data:

Suitable for: mild steel and aluminium from 3 to 6 mm
fabric-base plastics
non ferrous metal

No. teeth	L1 mm	L2 mm	L3 mm	D mm	Content	€		
129.3113	24	75,0	50,0	2,0	1,0	5	30	8,50

Jigsaw blades

- Faster and straight cut
- Ideal for aluminium

In the style of: AEG® 254315, Bosch® T127D, Metabo® 23639

Suitable for: Bosch®, AEG® (Atlas Copco), Metabo®, Lenox®, Milwaukee®, Elu®, Hitachi®, Holz-Her®, Mafell®, Makita®, Flex®, Sparky®

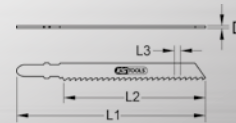

Technical data:

Suitable for: non ferrous metal and aluminium
plastic and eternit 2 to 20 mm

No. teeth	L1 mm	L2 mm	L3 mm	D mm	Content	€		
129.3118	24	100,0	75,0	3,0	1,15	5	40	11,90

Jigsaw blade

- Straight cut
- For thin material
- High performance steel

In the style of: AEG® 254063, Bosch® T118A, Metabo® 23637

Suitable for: Bosch®, AEG® (Atlas Copco), Metabo®, Lenox®, Milwaukee®, Elu®, Hitachi®, Holz-Her®, Mafell®, Makita®, Flex®, Sparky®

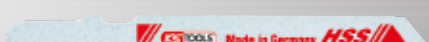
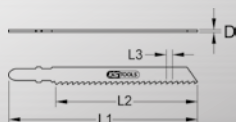

Technical data:

Suitable for: mild steel and aluminium
non ferrous metal 1.5 to 3.0 mm
stainless steel

No. teeth	L1 mm	L2 mm	L3 mm	D mm	Content	€		
129.3111	56	75,0	50,0	0,9	1,0	5	40	8,50

Bi metal jigsaw blades

- Straight cut
- Stainless steel

In the style of: Bosch® T111HF, Lenox® 410S

Suitable for: Bosch®, AEG® (Atlas Copco), Metabo®, Lenox®, Milwaukee®, Elu®, Hitachi®, Holz-Her®, Mafell®, Makita®, Flex®, Sparky®

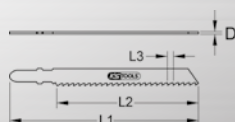

Technical data:

Suitable for: mild steel and aluminium
steel and non ferrous metal
stainless steel 3 to 12 mm

No. teeth	L1 mm	L2 mm	L3 mm	D mm	Content	€		
129.31135F	36	100,0	75,0	2,0	1,0	5	40	11,90

Bi metal jigsaw blades

- Faster and straight cut
- Flexible and shatter proof
- Ideal for aluminium
- Stainless steel

In the style of: Bosch® T127DF, Metabo® 23974, Lenox® 406S, Milwaukee® 48-42-5300

Suitable for: Bosch®, AEG® (Atlas Copco), Metabo®, Lenox®, Milwaukee®, Elu®, Hitachi®, Holz-Her®, Mafell®, Makita®, Flex®, Sparky®

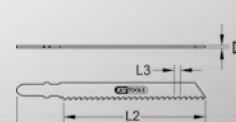

Technical data:

Suitable for: non ferrous metal and aluminium
plastic and eternit 3 to 15 mm
wooden with nails

No. teeth	L1 mm	L2 mm	L3 mm	D mm	Content	€		
129.3118F	24	100,0	75,0	3,0	1,27	5	40	13,90

Jigsaw blades

- Flexible and shatter proof
- ideal for non-ferrous metal, stainless steel, sheet steel, car body sheet, pressed materials and resopal

Suitable for: Ober, KS, Pneutec, CP, KS 515.3000 und 515.3200



	No. teeth	TPI	D mm	L mm	Content	g	€
129.3740	80	32	1,0	100,0	5	30	13,90
129.3742	60	24	1,0	100,0	5	30	13,90
129.3744	45	18	1,0	100,0	5	30	13,90
129.3746	35	14	2,0	100,0	5	30	13,90

Jigsaw blades

- Flexible and shatter proof
- ideal for non-ferrous metal, stainless steel, sheet steel, car body sheet, pressed materials and resopal

Suitable for: SIG und Flex



	No. teeth	TPI	D mm	L mm	Content	g	€
129.3750	80	32	0,7	100,0	5	20	13,90
129.3752	60	24	1,0	100,0	5	20	13,90
129.3754	45	18	1,4	100,0	5	20	13,90
129.3756	35	14	1,8	100,0	5	20	13,90



SABRE SAW BLADES

Sabre saw blades curved cut

- Fast cut
- With hardened teeth
- Ideal for aluminium

In the style of: AEG® 318-127, Bosch® S811H, Metabo® 31123, Flex® 200778

Suitable for: Bosch®, AEG® (Atlas Copco), Metabo®, Lenox®, Milwaukee®, Elu®, Hitachi®, Holz-Her®, Mafell®, Makita®, Flex®, Sparky®

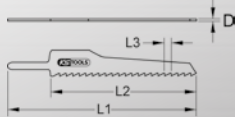

Technical data:

Suitable for: non ferrous metal and aluminium wood and chip chipboard 6 to 100 mm plastic and eternit

	No. teeth	L1 mm	L2 mm	L3 mm	D mm	Content	g	€
129.4010	66	300,0	280,0	4,2	1,3	5	240	20,50

Sabre saw blades curved cut

- Faster, cleaner, straighter and curve cut

In the style of: AEG® 318-126, Bosch® S644D, Black&Decker® 40109, Metabo® 31120, Dewalt® 40109, Milwaukee® 48-00-1031

Suitable for: Bosch®, AEG® (Atlas Copco), Metabo®, Lenox®, Milwaukee®, Elu®, Hitachi®, Holz-Her®, Mafell®, Makita®, Flex®, Sparky®

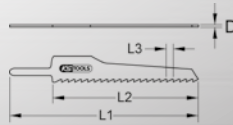

Technical data:

Suitable for: hardwood and softwood 6 to 100 mm chipboard and plywood plastic

	No. teeth	L1 mm	L2 mm	L3 mm	D mm	Content	g	€
129.4011	30	150,0	130,0	4,2	1,3	5	100	16,50

Sabre saw blades

- Fast cut
- Two sided cutting

In the style of: AEG® 318-131, Bosch® S828D, Black&Decker® 40127, Metabo® 31136, Flex® 206016, Milwaukee® 48-00-1052

Suitable for: Bosch®, AEG® (Atlas Copco), Metabo®, Lenox®, Milwaukee®, Elu®, Hitachi®, Holz-Her®, Mafell®, Makita®, Flex®, Sparky®

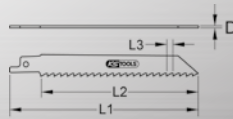

Technical data:

Suitable for: wood and plastic 6 to 100 mm plasterboard and aerated concrete

	No. teeth	L1 mm	L2 mm	L3 mm	D mm	Content	g	€
129.4014	30	150,0	130,0	4,2	1,3	5	130	18,50

Bi metal sabre saw blades

- Fast cut
- Long service life
- Flexible and shatter proof
- Ideal for thick walled cast iron pipe

In the style of: Bosch® S611DF, Lenox® 656R, Milwaukee® 48-01-5035

Suitable for: Bosch®, AEG® (Atlas Copco), Metabo®, Lenox®, Milwaukee®, Elu®, Hitachi®, Holz-Her®, Mafell®, Makita®, Flex®, Sparky®

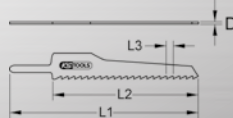

Technical data:

Suitable for: wood with nails and hardwood plasterboard and aerated concrete

	No. teeth	L1 mm	L2 mm	L3 mm	D mm	Content	g	€
129.4016	30	150,0	130,0	4,2	1,3	5	90	24,90

Sabre saw blades

- Especially suitable for fast cutting
- Fast, exact, coarse and curve cuts

In the style of: Bosch® S1617K

Suitable for: Bosch®, AEG® (Atlas Copco), Metabo®, Lenox®, Milwaukee®, Elu®, Hitachi®, Holz-Her®, Mafell®, Makita®, Flex®, Sparky®

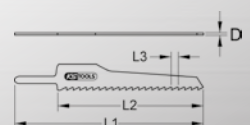

Technical data:

Suitable for: wood and greenwood hardwood and softwood 20 to 150 mm

	No. teeth	L1 mm	L2 mm	L3 mm	D mm	Content	g	€
129.4020	33	300,0	280,0	8,5	1,3	5	230	20,50

Sabre saw blades

- Coarse and fast cut
- Ideal for old building renovation
- Chrome vanadium

In the style of: Bosch® S1111K, Black&Decker® 40108

Suitable for: Bosch®, Black&Decker®, AEG® (Atlas Copco), Metabo®, Lenox®, Milwaukee®, DeWalt®, Hitachi®, Makita®, Rockwell®, Skil®, Flex®

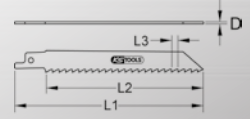

Technical data:

Suitable for: wood and greenwood hardwood and softwood 20 to 150 mm

	No. teeth	L1 mm	L2 mm	L3 mm	D mm	Content	g	€
129.4022	25	230,0	210,0	8,5	1,3	5	190	16,50

Sabre saw blades

- Coarse cut
- Especially suitable for fast cutting
- Ideal for old building renovation

In the style of: Flex® 200751

Suitable for: Bosch®, Black&Decker®, AEG® (Atlas Copco), Metabo®, Lenox®, Milwaukee®, DeWalt®, Hitachi®, Makita®, Rockwell®, Skil®, Flex®

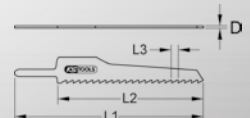

Technical data:

Suitable for: wood and plastic 20 to 100 mm plasterboard

	No. teeth	L1 mm	L2 mm	L3 mm	D mm	Content	g	€
129.4031	20	150,0	130,0	6,3	1,3	5	120	12,90

Sabre saw blades

- Faster and straight cut
- For thin material
- Flexible and shatter proof
- Stainless steel

In the style of: AEG ° 318-129, Bosch ° S922EF, Black&Decker ° 40116, Metabo ° 31132, Flex ° 200735, Lenox ° 618R, Milwaukee ° 48-00-5184

Suitable for: Bosch °, Black&Decker °, AEG ° (Atlas Copco), Metabo °, Lenox °, Milwaukee °, DeWalt °, Hitachi °, Makita °, Rockwell °, Skil °, Flex °

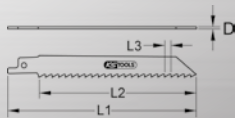

Technical data:

Suitable for: steel and stainless steel
non-ferrous metal and steel tubes
1.5 to 12 mm

	No. teeth	L1 mm	L2 mm	L3 mm	D mm	Content	g	€
129.4401	90	150,0	130,0	1,4	0,9	5	100	18,50

Sabre saw blades

- Faster and straight cut
- For thin materials
- Flexible and shatter proof
- Stainless steel

In the style of: AEG ° 318-128, Bosch ° S922AF, Black&Decker ° 40125, Metabo ° 31129, Flex ° 200743, Lenox ° 624R, Milwaukee ° 48-00-5186

Suitable for: Bosch °, Black&Decker °, AEG ° (Atlas Copco), Metabo °, Lenox °, Milwaukee °, DeWalt °, Hitachi °, Makita °, Rockwell °, Skil °, Flex °

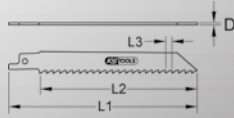

Technical data:

Suitable for: sheet steel and profile
non-ferrous metal up to 1 mm

	No. teeth	L1 mm	L2 mm	L3 mm	D mm	Content	g	€
129.4405	120	150,0	130,0	1,0	0,9	5	100	18,50

Sabre saw blades

- Clean cut
- Ideal for non ferrous metal

In the style of: Metabo ° 31124

Suitable for: Bosch °, AEG ° (Atlas Copco), Metabo °, Lenox °, Milwaukee °, Elu °, Hitachi °, Holz-Her °, Mafell °, Makita °, Flex °, Sparky °

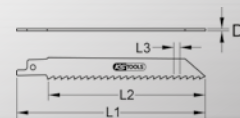

Technical data:

Suitable for: steel and non ferrous metal
steel tube 2 to 8 mm
wooden with nails

	No. teeth	L1 mm	L2 mm	L3 mm	D mm	Content	g	€
129.4422	154	300,0	280,0	1,8	0,9	5	200	32,50

Sabre saw blades

- Faster and straight cut
- For thin material
- Flexible and shatter proof
- Stainless steel

In the style of: Bosch ° S1122EF, Lenox ° 818R, Milwaukee ° 48-00-5188

Suitable for: Bosch °, AEG ° (Atlas Copco), Metabo °, Lenox °, Milwaukee °, Elu °, Hitachi °, Holz-Her °, Mafell °, Makita °, Flex °, Sparky °

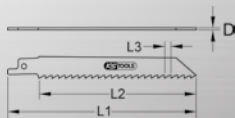

Technical data:

Suitable for: non-ferrous metal 1.5 to 3 mm
steel, profile and pipes

	No. teeth	L1 mm	L2 mm	L3 mm	D mm	Content	g	€
129.4402	126	200,0	180,0	1,4	0,9	5	130	22,50

Sabre saw blades

- Faster and straight cut
- Flexible and shatter proof
- For thick material
- Stainless steel

In the style of: AEG ° 318-130, Bosch ° S644D, Black&Decker ° 40113, Metabo ° 31134, Flex ° 200727, Lenox ° 614R, Milwaukee ° 48-00-5182

Suitable for: Bosch °, Black&Decker °, AEG ° (Atlas Copco), Metabo °, Lenox °, Milwaukee °, DeWalt °, Hitachi °, Makita °, Rockwell °, Skil °, Flex °

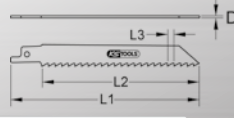

Technical data:

Suitable for: non-ferrous metal
steel and stainless steel
steel shet and steel tubes 2 to 8 mm

	No. teeth	L1 mm	L2 mm	L3 mm	D mm	Content	g	€
129.4411	70	150,0	130,0	1,8	0,9	5	100	18,50

Sabre saw blades

- Flexible and shatter proof
- Ideal for wood with nails

In the style of: Bosch ° S922HF, Metabo ° 31131, Flex ° 200778, Lenox ° 610R, Milwaukee ° 48-00-5092

Suitable for: Bosch °, Black&Decker °, AEG ° (Atlas Copco), Metabo °, Lenox °, Milwaukee °, DeWalt °, Hitachi °, Makita °, Rockwell °, Skil °, Flex °

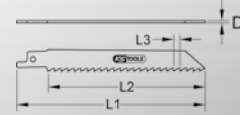

Technical data:

Suitable for: non-ferrous metal
steel, profile and steel tubes 3 to 12 mm
wooden with nails

	No. teeth	L1 mm	L2 mm	L3 mm	D mm	Content	g	€
129.4430	50	150,0	130,0	2,5	0,9	5	100	18,50



Sabre saw blades

- Faster and straight cut
- Flexible and shatter proof
- For thick material
- Stainless steel

In the style of: Metabo ° 31135

Suitable for: Bosch °, Black&Decker °, AEG ° (Atlas Copco), Metabo °, Lenox °, Milwaukee °, DeWalt °, Hitachi °, Makita °, Rockwell °, Skil °, Flex °

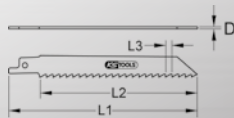

Technical data:

Suitable for: non-ferrous metal
steel and stainless steel
steel shet and steel tubes 2 to 8 mm

	No. teeth	L1 mm	L2 mm	L3 mm	D mm	Content	g	€
129.4415	98	200,0	180,0	1,8	0,9	5	130	22,50

Sabre saw blades

- Flexible and shatter proof
- Ideal for wood with nails

In the style of: Flex ° 217190, Lenox ° S810R
Suitable for: Bosch °, AEG ° (Atlas Copco), Metabo °, Lenox °, Milwaukee °, Elu °, Hitachi °, Holz-Her °, Mafell °, Makita °, Flex °, Sparky °

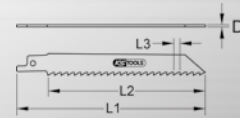

Technical data:

Suitable for: steel and steel tubes 3 to 12 mm
Aluminum and metal
profile and pallet construction 3 to 150 mm

	No. teeth	L1 mm	L2 mm	L3 mm	D mm	Content	g	€
129.4431	70	200,0	180,0	2,5	0,9	5	130	22,50

Sabre saw blades

- Flexible and shatter proof
- Ideal for wood with nails

In the style of: Bosch® S1211H, Metabo® 31125, Flex® 201928

Suitable for: Bosch®, AEG® (Atlas Copco), Metabo®, Lenox®, Milwaukee®, Elu®, Hitachi®, Holz-Her®, Mafell®, Makita®, Flex®, Sparky®

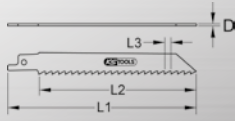

Technical data:

Suitable for: steel and steel tubes 3 to 12 mm
non ferrous metal and insulation material
wood with nails 3 to 230 mm

	No. tooth	L1 mm	L2 mm	L3 mm	D mm	Content	g	€
129.4432	110	300,0	280,0	2,5	0,9	5	200	32,50



Sabre saw blades

- Variable tooth pitch
- Straight cut
- Ideal for cutting pipes
- Stainless steel

Suitable for: Pipe cutting machines Rems®, Ridgid®, Rothenberger®, Virax®

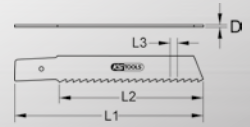

Technical data:

Suitable for: thick walled cast and steel pipe up to 50 mm
non-ferrous metal and aluminium steel

	No. tooth	L1 mm	L2 mm	L3 mm	D mm	Content	g	€
129.4483	45	140,0	120,0	2,5	1,7	5	220	36,50

Sabre saw blades

- Variable tooth pitch
- Flexible and shatter proof
- For different materials

In the style of: Lenox® 650R

Suitable for: Bosch®, Black&Decker®, AEG® (Atlas Copco), Metabo®, Lenox®, Milwaukee®, DeWalt®, Hitachi®, Makita®, Rockwell®, Skil®, Flex®

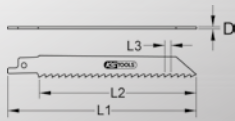

Technical data:

Suitable for: tube and profile
non ferrous metal 3 to 12 mm
wood with nails from 3 to 100 mm

	No. tooth	L1 mm	L2 mm	L3 mm	D mm	Content	g	€
129.4440V	70	150,0	130,0	1,8 - 2,5	1,3	5	130	24,90

Sabre saw blades

- Straight cut
- Ideal for cutting pipes
- Stainless steel

In the style of: Rems® 561003

Suitable for: Pipe cutting machines Rems®

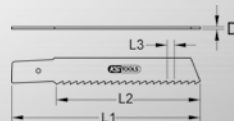

Technical data:

Suitable for: steel and non ferrous metal
tube and profile up to 100 mm

	No. tooth	L1 mm	L2 mm	L3 mm	D mm	Content	g	€
129.4454	98	200,0	180,0	1,8	0,9	5	180	33,50

Sabre saw blades

- Straight cut
- Ideal for cutting pipes
- Stainless steel

In the style of: Rems® 561002

Suitable for: Pipe cutting machines Rems®

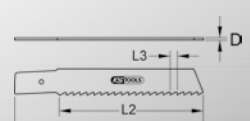

Technical data:

Suitable for: steel and non ferrous metal
thick walled cast and steel pipe up to 10 mm

	No. tooth	L1 mm	L2 mm	L3 mm	D mm	Content	g	€
129.4486	56	200,0	180,0	3,2	1,6	5	300	46,50

Sabre saw blades

- Variable tooth pitch
- Flexible and shatter proof
- For different materials
- Stainless steel

Suitable for: Bosch®, AEG® (Atlas Copco), Metabo®, Lenox®, Milwaukee®, Elu®, Hitachi®, Holz-Her®, Mafell®, Makita®, Flex®, Sparky®

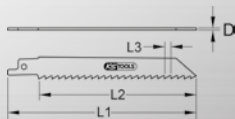

Technical data:

Suitable for: metal from 3 to 12 mm
wood with nails from 3 to 190 mm
plastic

	No. tooth	L1 mm	L2 mm	L3 mm	D mm	Content	g	€
129.4441V	98	200,0	180,0	1,8 - 2,5	1,3	5	40	29,90

Sabre saw blades

- Straight cut
- Ideal for cutting pipes
- Stainless steel

In the style of: Rems® 561001

Suitable for: Pipe cutting machines Rems®

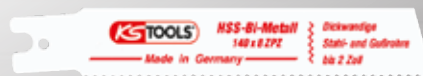
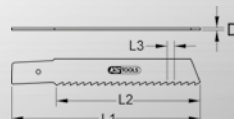

Technical data:

Suitable for: steel and non ferrous metal
cast and steel pipe from 4 mm
Aluminium

	No. tooth	L1 mm	L2 mm	L3 mm	D mm	Content	g	€
129.4482	36	140,0	120,0	3,2	1,6	5	220	37,50



HAND WIRE BRUSHES

Steel hand wire brush 3 rowed

- 3 rowed
- Universal usage
- wooden handle
- For surface preparation
- With steel bristles

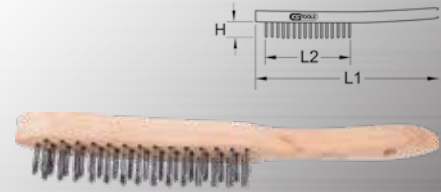

	H mm	L1 mm	L2 mm	g	€
201.2305	32,0	290,0	138,0	120	3,50

Steel hand wire brush 4 rowed

- 4 rowed
- Universal usage
- wooden handle
- For surface preparation
- With steel bristles

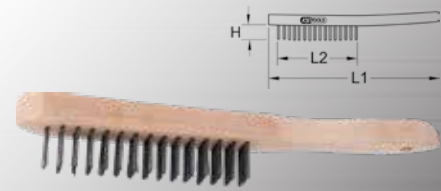

	H mm	L1 mm	L2 mm	g	€
201.2311	32,0	290,0	138,0	120	3,50

Stainless steel hand wire hand brush 3 rowed

- 3 rowed
- Universal usage
- wooden handle
- For surface preparation
- With stainless steel bristles

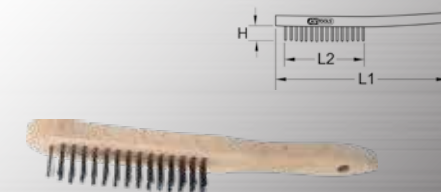

	H mm	L1 mm	L2 mm	g	€
201.2310	32,0	290,0	138,0	120	3,50

Stainless steel hand wire hand brush 4 rowed

- 4 rowed
- Universal usage
- wooden handle
- For surface preparation
- With stainless steel bristles



	H mm	L1 mm	L2 mm	g	€
201.2306	32,0	290,0	138,0	100	4,50

Steel wire all purpose wire brush

- With plastic handle
- For surface preparation
- Crimped steel wire



	H mm	L1 mm	L2 mm	g	€
201.2300	28,0	250,0	145,0	90	3,50

Stainless steel wire all purpose wire brush

- With plastic handle
- For surface preparation
- Curled and rust free steel wire



	H mm	L1 mm	L2 mm	g	€
201.2301	28,0	250,0	145,0	90	3,50

Brass steel all purpose wire brush

- With plastic handle
- For surface preparation
- Curved brass wire

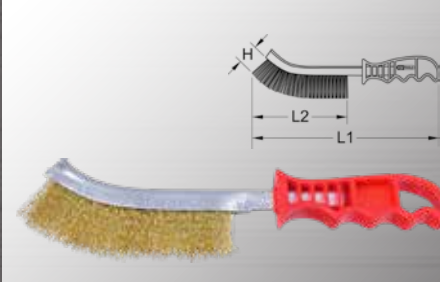

	H mm	L1 mm	L2 mm	g	€
201.2302	28,0	250,0	145,0	90	4,50

Steel wire brake saddle brush, 2-row, straight

- 2 rowed
- With hanging hole
- Very narrow execution
- For narrow brake saddle shafts
- Robust stock
- One component handle
- For removing of stubborn brake dust
- For surface preparation
- Smooth steel wire

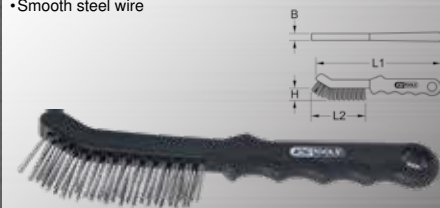

	B mm	H mm	L1 mm	L2 mm	g	€
201.2335	12,0	22,0	225,0	90,0	90	

Brass wire brake saddle brush, 2-row, straight

- 2 rowed
- Very narrow execution
- For narrow brake saddle shafts
- Robust stock
- With hanging hole
- One component handle
- For removing of stubborn brake dust
- For surface preparation
- Straight brass wire



	B mm	H mm	L1 mm	L2 mm	g	€
201.2340	12,0	22,0	225,0	90,0	90	

Brass wire hand brush 3 rowed

- 3 rowed
- Universal usage
- Plastic hand grip casing
- For surface preparation
- Straight brass wire



	H mm	L1 mm	L2 mm	g	€
201.2326	25,0	285,0	130,0	105	14,90

Steel wire hand brush 4 rowed

- 4 rowed
- Universal usage
- Plastic hand grip casing
- For surface preparation
- Smooth steel wire



	H mm	L1 mm	L2 mm	g	€
201.2325	25,0	285,0	130,0	120	10,90

Steel wire brake saddle wire brush 2 rowed, straight

- 2 rowed
- With hanging hole
- Very narrow execution
- For narrow brake saddle shafts
- Robust stock
- Two component handle
- For removing of stubborn brake dust
- For surface preparation
- Smooth steel wire

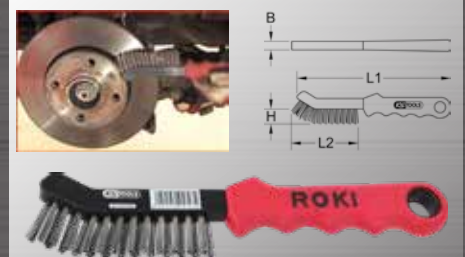

	B mm	H mm	L1 mm	L2 mm	g	€
201.2320	12,0	22,0	225,0	90,0	90	10,90

Steel wire brake saddle wire brush 2 rowed, straight and tapered point

- 2 rowed
- With hanging hole
- Tapered point
- Very narrow execution
- For narrow brake saddle shafts
- Robust stock
- Two component handle
- For removing of stubborn brake dust
- For surface preparation
- Smooth steel wire

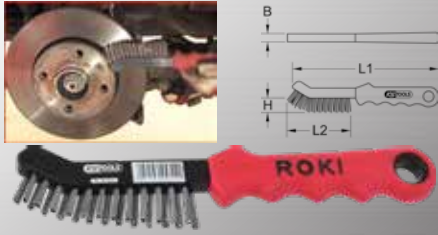

	B mm	H mm	L1 mm	L2 mm	g	€
201.2321	12,0	14,0 - 22,0	225,0	90,0	90	10,90

Brass wire brake saddle wire brush 2 rowed, straight

- 2 rowed
- Very narrow execution
- For narrow brake saddle shafts
- Robust stock
- With hanging hole
- Two component handle
- For removing of stubborn brake dust
- For surface preparation
- Curved brass wire

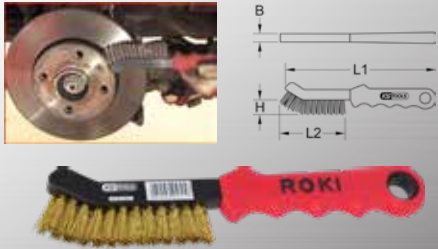

	B mm	H mm	L1 mm	L2 mm	g	€
201.2322	12,0	22,0	225,0	90,0	90	16,50

Brass wire spark plug wire brush 2 rowed

- 2 rowed
- For gentle cleaning of electrodes and contacts on spark plugs
- For surface preparation
- Brass wire



	H mm	L1 mm	L2 mm	g	€
201.2316	14,8	170,0	24,5	20	2,50

Steel wire spark plug wire brush 2 rowed

- 2 rowed
- For gentle cleaning of electrodes and contacts on spark plugs
- For surface preparation
- Steel wire

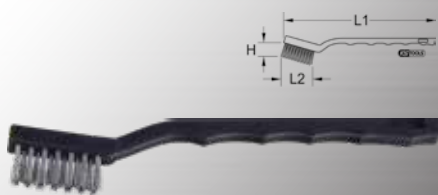

	H mm	L1 mm	L2 mm	g	€
201.2315	14,8	170,0	24,5	20	1,50

MACHINE OPERATED WIRE BRUSHES

Steel wire jar brush 0,3 mm

- With 6 mm mandril
- To enable with high rotary speed
- Long durability through compact border
- For use with drill machine
- For surface preparation
- Crimped steel wire

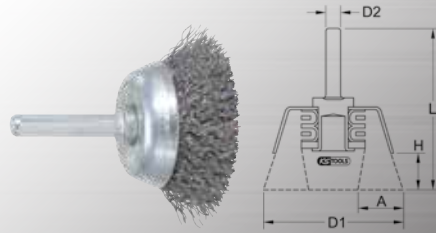

	RPM max	D1 mm	D2 mm	A mm	H mm	L mm	g	€
340.0001	4500	38,0	6,0	12,0	15,0	55,0	50	3,50
340.0002	4500	50,0	6,0	13,0	15,0	63,0	60	4,50
340.0003	4500	65,0	6,0	10,0	20,0	70,0	70	4,50
340.0004	4500	75,0	6,0	15,0	25,0	73,0	80	4,50

Rust free steel jar brush 0,3 mm

- With 6 mm mandril
- To enable with high rotary speed
- Long durability through compact border
- For use with drill machine
- For surface preparation
- Curled and rust free steel wire

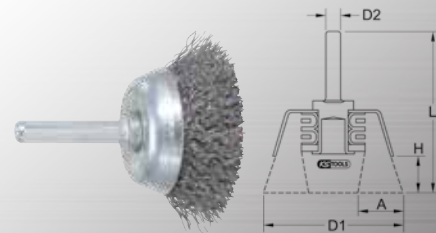

	RPM max	D1 mm	D2 mm	A mm	H mm	L mm	g	€
340.0011	4500	38,0	6,0	12,0	14,0	55,0	50	4,50
340.0012	4500	50,0	6,0	13,0	15,0	63,0	60	4,50
340.0013	4500	65,0	6,0	10,0	20,0	70,0	70	5,50
340.0014	4500	75,0	6,0	15,0	25,0	73,0	80	5,50

Paint brush steel wire brush 0,3 mm

- With 6 mm mandril
- For use with drill machine
- For difficult to access areas
- For surface preparation
- Crimped steel wire



	RPM max	D1 mm	D2 mm	H mm	L mm	g	€
340.0016	20000	19,0	6,0	25,0	70,0	30	6,50
340.0017	18000	25,0	6,0	25,0	73,0	40	6,50
340.0018	18000	30,0	6,0	25,0	76,0	50	6,50

Paint brush steel wire brush 0,5 mm

- With 6 mm mandril
- For use with drill machine
- For difficult to access areas
- For surface preparation
- Crimped steel wire



	RPM max	D1 mm	D2 mm	H mm	L mm	g	€
340.0019	20000	19,0	6,0	25,0	70,0	30	5,50
340.0020	18000	25,0	6,0	25,0	73,0	40	5,50
340.0021	18000	30,0	6,0	25,0	76,0	40	5,50

Steel wire jar brush 0,5 mm

- Braided design
- With thread arbor
- For use in one hand angle grinder
- Ideal for heavy brush works
- For surface preparation
- Crimped steel wire



	RPM max	mm	D mm	H mm	L mm	No. plates	g	€
340.0022	12500	M14 x 2,0	65,0	20,0	50,0	16	160	7,50
340.0023	11500	M14 x 2,0	80,0	19,0	61,0	18	200	7,50
340.0024	10000	M14 x 2,0	90,0	22,0	60,0	18	240	9,90

Rust free stainless steel wire jar brush 0,5 mm

- Braided design
- With thread arbor
- For use in one hand angle grinder
- Ideal for heavy brush works
- For surface preparation
- Curled and rust free steel wire



	RPM max	mm	D mm	H mm	L mm	No. plates	g	€
340.0025	12500	M14 x 2,0	65,0	20,0	50,0	16	160	10,90
340.0026	11500	M14 x 2,0	75,0	20,0	50,0	18	200	12,90
340.0027	10000	M14 x 2,0	90,0	22,0	60,0	18	240	14,90

Steel wire brush disc 0,3 mm

- With 6 mm mandril
- Especially longlife industry version
- For use with drill machine
- For surface preparation
- Crimped steel wire

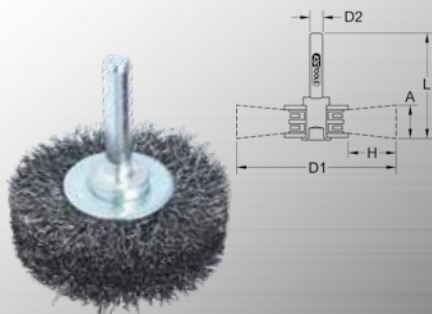

	RPM max	D1 mm	D2 mm	A mm	H mm	L mm		€
340.0028	20000	38,0	6,0	9,0	6,0	38,0	40	4,50
340.0029	15000	50,0	6,0	14,0	12,0	45,0	40	4,50
340.0030	15000	63,0	6,0	14,0	17,0	45,0	60	4,50
340.0032	15000	75,0	6,0	18,0	20,0	50,0	100	5,50

Steel wire circular brush 0,5 mm

- Braided design
- With 6 mm mandril
- Especially longlife industry version
- For use in with drill machine
- For removing of underbody coating
- For surface preparation
- Smooth steel wire

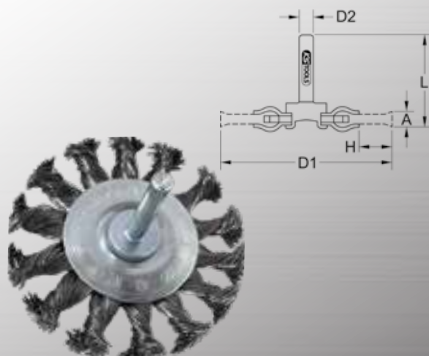

	RPM max	D1 mm	D2 mm	A mm	H mm	L mm		€
340.0039	15000	75,0	6,0	12,0	15,0	43,0	100	6,50

Cone design steel wire circular brush 0,5 mm

- Braided design
- With thread arbor
- Especially longlife industry version
- For use in one hand angle grinder
- For hard to reach places
- For surface preparation
- Smooth steel wire

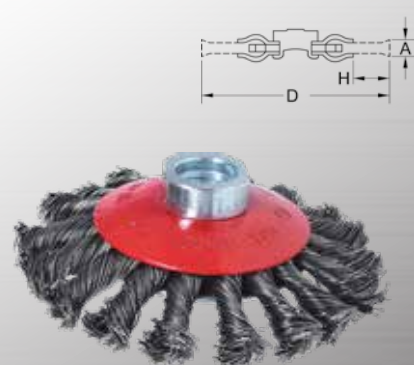

	RPM max		D mm	A mm	H mm	No. plates		€
340.0048	12500	M 14 x 2,0	100,0	14,0	21,0	18	190	7,50
340.0049	12500	M 14 x 2,0	115,0	14,0	21,0	20	210	7,50

Rust free steel wire brush disc 0,3 mm

- With 6 mm mandril
- Especially longlife industry version
- For use with drill machine
- For surface preparation
- Curled and rust free steel wire

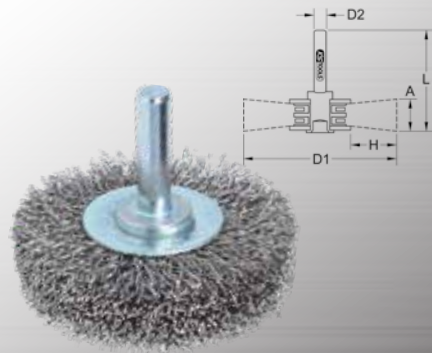

	RPM max	D1 mm	D2 mm	A mm	H mm	L mm		€
340.0033	20000	38,0	6,0	9,0	6,0	38,0	40	6,50
340.0034	15000	50,0	6,0	14,0	12,0	45,0	40	5,50
340.0035	15000	63,0	6,0	14,0	17,0	45,0	60	7,50
340.0037	15000	75,0	6,0	16,0	20,0	48,0	100	9,90

Steel wire circular brush 0,5 mm

- Braided design
- Longlife industry version
- For use in one hand angle grinder
- For removing of rubber, grate and lacquer residue
- For surface preparation
- Smooth steel wire

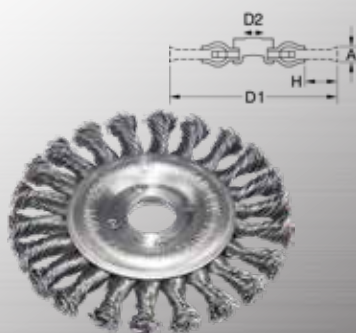

	RPM max	D1 mm	D2 mm	A mm	H mm	No. plates		€
340.0041	12500	100,0	22,2	11,0	20,5	18	120	8,50
340.0042	12500	115,0	22,2	14,0	22,0	20	140	8,50
340.0043	12500	125,0	22,2	14,0	27,0	20	150	9,90

Rust free cone design steel wire circular brush 0,5 mm

- Braided design
- With thread arbor
- Especially longlife industry version
- For use in one hand angle grinder
- For hard to reach places
- For surface preparation
- Flat and grate free steel wire

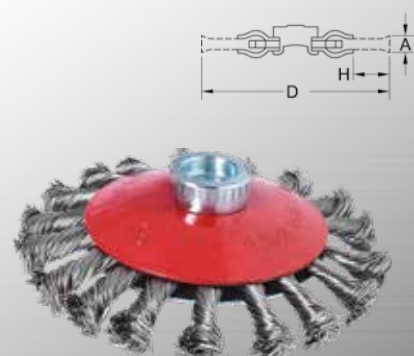

	RPM max		A mm	D mm	H mm	No. plates		€
340.0050	12500	M 14 x 2,0	14,0	100,0	21,0	18	190	11,90
340.0051	12500	M 14 x 2,0	14,0	115,0	21,0	20	210	11,90

Steel wire circular brush 0,3 mm

- Braided design
- With 6 mm mandril
- Especially longlife industry version
- For use in with drill machine
- For removing of underbody coating
- For surface preparation
- Smooth steel wire

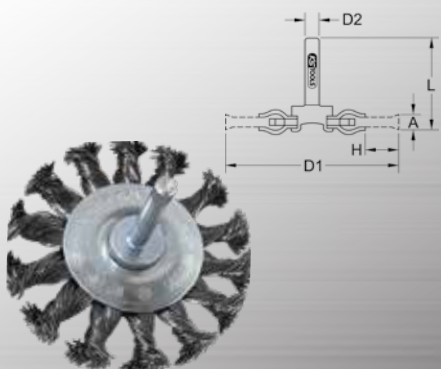

	RPM max	D1 mm	D2 mm	A mm	H mm	L mm		€
340.0038	15000	75,0	6,0	12,0	15,0	43,0	100	6,50

Stainless steel and brushed steel 0,5 mm

- Braided design
- Longlife industry version
- For use in one hand angle grinder
- For removing of rubber, grate and lacquer residue
- For surface preparation
- Flat and grate free steel wire

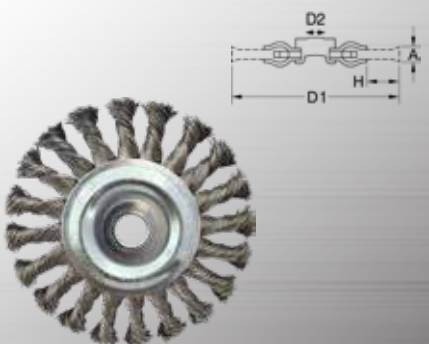

	RPM max	D1 mm	D2 mm	A mm	H mm	No. plates		€
340.0045	12500	100,0	22,2	11,0	20,5	18	120	11,90
340.0046	12500	115,0	22,2	11,0	23,5	20	140	13,90
340.0047	12500	125,0	22,2	14,0	27,0	20	150	12,90

CUT OFF AND FLAP WHEELS

Clamping mandrel

- High performances thin disks
- Special tool steel



	Shank mm	Profile		€
515.3017	6,0	round	72	20,50

High performances thin cutting disk

- Exact and clean cut
- No deburring necessary
- Very short cutting times
- Machine load reduced
- Inox stainless steel

Ideal for use in very thin materials until 2.5 mm, tool steel, sheet metal, thin walled pipes and profiles all type suited for locksmiths, car body building, sanitary and heating fitting, plumbing, sheet metal processing, carpentry, joinery, roofing, metal processing and all motor vehicles businesses.



	RPM max	D1 mm	D2 mm	H mm	Content	g	€
337.2005	13300	50,0	6,0	1,0	25	100	35,50
337.2010	15250	100,0	16,0	1,6	25	1200	50,50
337.2015	13300	115,0	22,2	1,0	25	730	32,50
337.2025	12200	125,0	22,2	1,0	25	800	32,50

RASP

Installation rasp

- Machined cut
- Two component handle
- Special tool steel

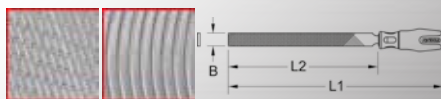

	L1 mm	L2 mm	B mm	File Blade	g	€
157.0123	370,0	250,0	22,0	161.0123	270	26,90

Installation rasp insert

- Machined cut
- Special tool steel

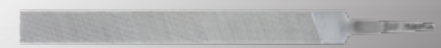

	L mm	B mm	File Blade	g	€
161.0123	250,0	22,0	161.0011	170	20,50

FILE BRUSHES

File Brush

- Universal usage
- wooden handle
- for ribbed surfaces cleaning, such as filing
- Bristle area 110 x 38 mm
- with steel wire



	L mm	H mm	g	€
161.0001	250,0	20,0	85	7,50

FILES

Flat needle file

- High cutting rate
- With solid plastic handle
- For working in the area of the fine mechanics
- Special tool steel

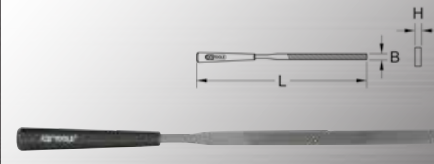

	B mm	H mm	L mm	g	€
140.3051	5,0	1,0	145,0	10	1,50

Half round needle file

- High cutting rate
- With solid plastic handle
- For working in the area of the fine mechanics
- Special tool steel



	D mm	L mm	g	€
140.3058	5,0	145,0	10	1,50

Round needle file

- High cutting rate
- With solid plastic handle
- For working in the area of the fine mechanics
- Special tool steel



	D mm	L mm	g	€
140.3052	3,0	145,0	10	2,50

Square needle file

- High cutting rate
- With solid plastic handle
- For working in the area of the fine mechanics
- Special tool steel



	B mm	L mm	g	€
140.3056	2,0	145,0	10	1,50

Three square needle file

- High cutting rate
- With solid plastic handle
- For working in the area of the fine mechanics
- Special tool steel



	B mm	L mm	g	€
140.3054	3,0	145,0	10	1,50

Square needle file, extra slim

- High cutting rate
- Extra slim design
- With solid plastic handle
- For working in the area of the fine mechanics
- Special tool steel



	B mm	L mm	g	€
140.3055	2,0	90,0	10	1,50

Oval needle file

- High cutting rate
- With solid plastic handle
- For working in the area of the fine mechanics
- Special tool steel



	B mm	L mm	g	€
140.3059	5,0	145,0	10	1,50

Insert needle files

- High cutting rate
- With solid plastic handle
- For working in the area of the fine mechanics
- Special tool steel



	B mm	L mm	g	€
140.3057	5,0	145,0	10	1,50

Square file insert

- DIN 7261 Form D
- Special tool steel



		L mm	B mm			€
161.0324	1	150,0	6,0	161.0012	30	3,50
161.0325	1	200,0	8,0	161.0013	70	3,50
161.0326	1	250,0	10,0	161.0011	150	5,50
161.0304	2	150,0	6,0	161.0012	30	3,50
161.0305	2	200,0	8,0	161.0013	70	4,50
161.0306	2	250,0	10,0	161.0011	150	5,50
161.0314	3	150,0	6,0	161.0012	30	3,50
161.0315	3	200,0	8,0	161.0013	70	4,50

Three square file

- DIN 7261 form C
- Two component handle
- Special tool steel

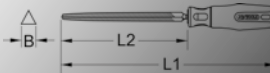

		L1 mm	L2 mm	B mm	File shape		€
157.0424	1	230,0	150,0	11,0	161.0424	170	7,50
157.0425	1	320,0	200,0	15,0	161.0425	240	9,90
157.0426	1	370,0	250,0	17,5	161.0426	380	8,50
157.0427	1	420,0	300,0	20,0	161.0427	520	11,90
157.0404	2	230,0	150,0	11,0	161.0404	170	9,90
157.0405	2	320,0	200,0	15,0	161.0405	240	7,50
157.0406	2	370,0	250,0	17,5	161.0406	380	11,90
157.0407	2	420,0	300,0	20,0	161.0407	520	13,90
157.0414	3	230,0	150,0	11,0	161.0414	170	9,90
157.0415	3	320,0	200,0	15,0	161.0415	240	11,90
157.0416	3	370,0	250,0	17,5	161.0416	200	10,90

Three square file insert

- DIN 7261 form C
- Special tool steel

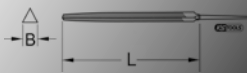

		L mm	B mm			€
161.0424	1	150,0	11,0	161.0012	70	3,50
161.0425	1	200,0	15,0	161.0013	140	4,50
161.0426	1	250,0	17,5	161.0011	280	5,50
161.0427	1	300,0	20,0	161.0011	420	8,50
161.0404	2	150,0	11,0	161.0012	70	3,50
161.0405	2	200,0	15,0	161.0013	140	4,50
161.0406	2	250,0	17,5	161.0010	300	6,50
161.0407	2	300,0	20,0	161.0011	420	9,90
161.0414	3	150,0	11,0	161.0012	70	4,50
161.0415	3	200,0	15,0	161.0013	140	4,50
161.0416	3	250,0	17,5	161.0010	300	6,50

File handle

- For rectangle and round reception
- Two component handle

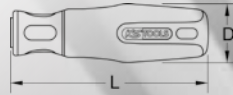

		D mm	L mm		€
161.0010		39,0	120,0	80	3,50
161.0011		39,0	120,0	80	3,50
161.0012		28,0	80,0	40	2,50
161.0013		35,0	106,0	65	3,50

Workshop file set

- DIN 7261 form B, C, D, E, F
- Second cut
- 200 mm long
- Two component handle
- Special tool steel

Includes one flat, halfround, round, square and triangular file with a length of 200 mm and second cut



				€
140.3000	5 pcs	Workshop file set	900	29,90
1 x		200 mm		
1 x		200 mm		
1 x		200 mm		
1 x		200 mm		
1 x		200 mm		



THREAD FILES

Thread file, metric

- For the restoration of defective internal and external threads
- Suitable for right and left-handed thread
- Serviceable from both sides
- Special tool steel

Suitable for thread pitch: 0.8 - 3.0 mm



	L mm		€
150.1340	230,0	130	44,90

Thread file, imperial

- For the restoration of defective internal and external threads
- Suitable for right and left-handed thread
- Serviceable from both sides
- Special tool steel

Suitable for thread pitch: 24 - 10 pitch imperial

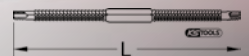

	L mm		€
150.1345	230,0	130	44,90

Your Local Distributor:

PREMIUM-WERKZEUGE

 PREMIUM TOOLS

KS Tools Werkzeuge - Maschinen GmbH

Seligenstädter Grund 10 - 12
 D-63150 Heusenstamm

GERMANY

Tel.: +49(0) 61 04 49 74-0

Fax: +49(0) 61 04 49 74-11

e-mail: kstools@kstools.de

www.kstools.com



LL22-26EN_EUR